

SONICWARE

LIVEN  
 Fm

User's Manual

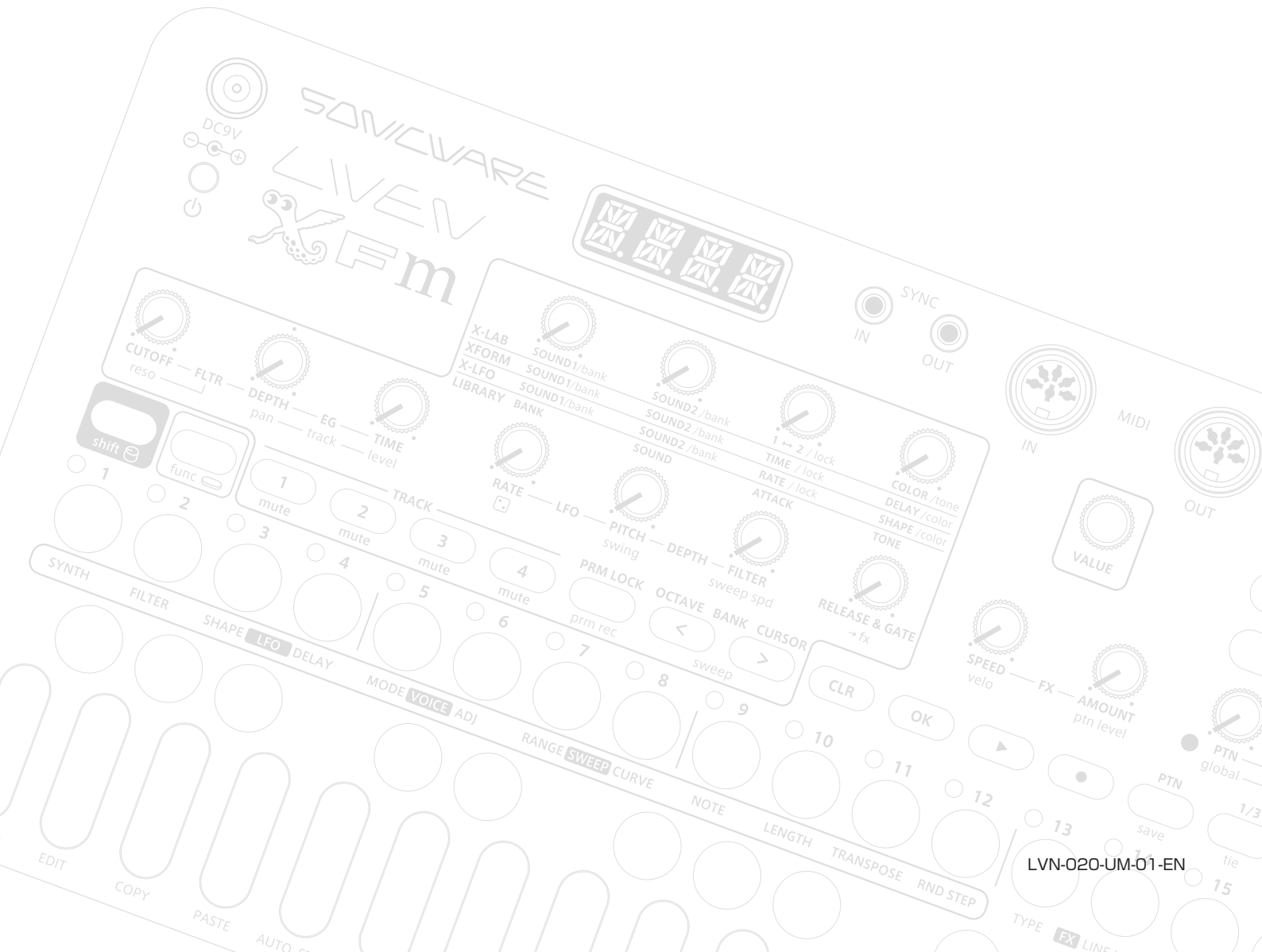

---

## FCC regulation warning (for USA)

Note: This equipment has been tested and found to comply with the limits for a Class B digital device, pursuant to part 15 of the FCC Rules. These limits are designed to provide reasonable protection against harmful interference in a residential installation. This equipment generates, uses and can radiate radio frequency energy and, if not installed and used in accordance with the instructions, may cause harmful interference to radio communications. However, there is no guarantee that interference will not occur in a particular installation. If this equipment does cause harmful interference to radio or television reception, which can be determined by turning the equipment off and on, the user is encouraged to try to correct the interference by one or more of the following measures:

- Reorient or relocate the receiving antenna.
- Increase the separation between the equipment and receiver.
- Connect the equipment into an outlet on a circuit different from that to which the receiver is connected.
- Consult the dealer or an experienced radio/TV technician for help.

## Legal disclaimers

Sonicware Inc. (hereafter, "SONICWARE" strives to assure that this document is as accurate and current as possible, but will bear no responsibility for any compensation, claims or losses due to content included in this document. Moreover, information in this document could be changed without notice. SONICWARE retains the right to change product specifications and programs at any time. SONICWARE will bear no responsibility for any errors depicted in this document. SONICWARE will bear no responsibility for any losses resulting from the use of this information, functions or performance, regardless of contracts, lack of caution or other conduct.

## Copyrights and registered trademarks

- SONICWARE is a registered trademark of Sonicware Inc.
- MIDI is a registered trademark of the Association of Musical Electronics Industry (AMEI).
- Other company names, product names, standard names and registered trademarks in this document are the property of their respective owners.
- All the trademarks and registered trademarks in this document are not intended to violate the copyrights of their owners, but rather are included for the purpose of identification only.
- Recording from copyrighted sources, including audio files, CDs, records, videos, tapes, broadcasts, streamed content and works of art, without permission of the copyright holder for any purpose other than personal use is prohibited by law.
- Sonicware Inc. will not assume any responsibility related to infringements of copyrights.

## Important safety precautions

You must read the following precautions in order to use the product safely and prevent accidents.

**WARNING: Failure to follow these precautions could result in serious harm to the user or even death.**

- Operation using an AC adapter
  - Do not do anything that could exceed the ratings of outlets and other electrical wiring equipment.
  - Disconnect the AC adapter with USB output from the outlet when lightning occurs and when not in use for a periods of time.
- Operation using batteries
  - Use-commercially available 1.5V AA batteries.
  - Carefully read the precautions of the batteries being used.

---

Be sure to insert the batteries with +/ – ends oriented correctly.

Do not use new and old batteries together. Do not use batteries of different types together.

Remove the batteries when they will not be used for a long time.

If a leak occurs, thoroughly wipe the battery compartment and battery terminals to remove the leaked fluid.

- Do not open the case and disassemble or modify the product.
- Do not drop, strike or apply excessive force to the unit.
- Did not put liquid on or in the unit.
- Do not put foreign objects into the case.
- Do not use at a loud volume. Doing so could generate loud sounds that might lead to hearing loss.
- When transporting this unit, use the individual packing box and cushioning material that it came with when purchased new.
- When the unit is powered on, do not wrap it in cloth, plastic or other materials.
- Do not step on or apply pressure to the power cord.
- Do not use in the following environmental conditions. Doing so could cause malfunctions.

Locations with direct sunlight, environments that exceed 40°C, or near stoves and other heat sources

Locations with extremely low or high temperatures

Locations with extremely high humidity or where the product could become wet

Locations with frequent vibrations or much dust or sand

- If the unit becomes broken or malfunctions, immediately turn the power off and stop using it.

## Usage Precautions

**Failure to follow these precautions could cause injury to the user and physical damage.**

- When connecting cables or turning the unit on or off, minimize the input levels of connected devices or turn them off.
- Cleaning

If the screen or the case become dirty, wipe them gently with a soft cloth.  
Do not use chemicals, including alcohol, benzene, thinner or cleansers.  
If a soft dry cloth is not enough to clean the unit, wipe them with a slightly damp cloth that has been wrung out well.  
Do not turn the power on until the unit is completely dry.

# Contents

<b>Preparing to play</b> .....	<b>5</b>	Recording sound locking automation to steps .....	18
Part names .....	5	Turning parameter locking automation on/off .....	18
Connecting .....	5	Initializing parameter lock automation .....	19
Preparing for startup .....	6	Clearing note and parameter lock automation data .....	19
Starting up .....	6	Changing the track length .....	19
Turning the unit off .....	6	Changing the note length of a single step .....	19
Sound memories, tracks, and patterns .....	6	Setting the track playback unit used during random playback .....	19
Tracks .....	6	<b>Sound editing</b> .....	<b>20</b>
<b>Basic operations</b> .....	<b>7</b>	Editing sounds .....	20
Adjusting the overall volume .....	7	Clearing sounds .....	20
Changing the octave range .....	7	Copying sounds .....	20
Basic knob operation .....	7	Changing sound names .....	21
Selecting and playing tracks .....	7	Changing sound bank names .....	21
Changing the velocity .....	7	Capturing synth engine sounds (capture mode) .....	21
Sweeping notes while playing .....	7	<b>Creating sounds with operators using the editing overlay</b> .....	<b>22</b>
Holding notes .....	7	Selecting the operator to edit .....	22
Changing step button parameters .....	7	Muting operators .....	22
<b>Track settings</b> .....	<b>8</b>	Setting connection levels and feedback between operators .....	22
Selecting tracks .....	8	Setting operator ratios .....	22
Clearing all notes in a track .....	8	Setting operator levels .....	23
Restoring track sound settings to the last saved state .....	8	Setting operator detuning .....	23
Changing the synth engine .....	8	Setting operators to fixed mode .....	23
Adjusting synth engines .....	8	Setting the frequency when in fixed mode .....	23
Changing the filter type .....	9	Setting operator envelopes .....	23
Changing the filter cutoff frequency .....	9	Setting operator envelope curves .....	24
Adjusting the filter envelope .....	9	Turning the pitch envelope on/off .....	24
Changing the LFO type .....	9	Setting the pitch envelope .....	24
Changing the LFO starting delay .....	9	Setting the operator keyboard gain scaling depths (left/right) .....	24
Adjusting the LFO speed .....	10	Setting the operator keyboard gain scaling curves (left/right) .....	25
Adjusting the amount of LFO effect on pitch .....	10	Setting the operator keyboard gain scaling position .....	25
Adjusting the amount of LFO effect on filter cutoff .....	10	Setting operator velocity sensitivity .....	25
Changing track note playback probability .....	10	Setting the operator keyboard time scaling .....	25
Setting the level of track output sent to the effect .....	10	Setting operator to mixer connection levels .....	26
Changing the sweep amount .....	10	Setting the mixer output level .....	26
Changing the sweep speed .....	10	Selecting algorithms and setting operator connections .....	26
Changing the sweep curve .....	10	Changing the voice mode and playing during sound editing .....	27
Changing track pitch by semitone (transposing) .....	11	<b>External input settings</b> .....	<b>28</b>
Changing the voice mode .....	11	Changing the FX send amount .....	28
Changing the legato speed .....	11	Changing the gain .....	28
Changing the arpeggiator type .....	11	Setting mono/stereo .....	28
Changing the track swing amount .....	11	<b>MIDI settings</b> .....	<b>29</b>
Changing the track release and gate time .....	11	Setting track MIDI channels .....	29
Changing track levels .....	12	Setting the MIDI channels for pattern parameters .....	29
Adjusting track panning .....	12	Setting the MIDI channel for accessing the active track (auto channel) .....	29
Muting tracks .....	12	Setting the output channel .....	29
Setting track MIDI channels .....	12	Setting the program change channel .....	29
Copying tracks .....	12	Turning control change transmission on/off .....	29
<b>Pattern playback and settings</b> .....	<b>13</b>	Turning MIDI clock output on/off .....	29
Pattern playback .....	13	Setting MIDI OUT .....	29
Selecting patterns .....	13	Setting MIDI command receipt and transmission .....	29
Changing pattern volume .....	13	Turning active sensing transmission on/off .....	30
Selecting multiple patterns and playing them in order (chain playback) .....	13	Turning active sensing reception on/off .....	30
Saving patterns .....	13	Turning program change transmission on/off .....	30
Initializing patterns .....	14	Turning program change reception on/off .....	30
Reloading patterns .....	14	<b>Saving and loading user data</b> .....	<b>31</b>
Changing the effect type .....	14	Exporting pattern data .....	31
Changing effect parameters .....	14	Exporting sound data .....	31
Setting the sequencer mode .....	14	Exporting sound banks .....	31
Setting pattern BPM .....	15	Importing sound data .....	31
Setting the global BPM .....	15	Importing sound banks .....	31
Setting the BPM mode .....	15	Backing up user data .....	31
Adjusting the metronome volume .....	15	Restoring user data .....	32
Changing pattern names .....	15	<b>System settings</b> .....	<b>33</b>
Synchronizing the tempo with another device connected to the SYNC IN .....	16	Setting the automatic power off function .....	33
Synchronizing tempo with an ELZ_1 or Pocket Operator (PO) .....	16	Setting the battery type .....	33
Examples of synchronization connections with external devices .....	16	Setting the master tuning .....	33
Setting the clock source .....	33	Setting SYNC IN polarity .....	33
Setting SYNC OUT polarity .....	33	Setting SYNC OUT polarity .....	33
Setting knob movement behavior .....	33	Setting the headphone gain .....	34
Enabling/disabling speaker output .....	34	Checking the system version .....	34
Setting the headphone gain .....	34	Restoring to factory default settings (factory reset) .....	34
Checking the system version .....	34	Updating the firmware .....	34
Restoring to factory default settings (factory reset) .....	34	<b>Appendix</b> .....	<b>36</b>
Updating the firmware .....	34		
<b>Track sequencing</b> .....	<b>17</b>		
Step recording .....	17		
Copying and pasting steps during step recording .....	17		
Automatically advancing steps during step recording (auto step mode) .....	17		
Recording in real time .....	17		
Directly inputting notes on steps .....	18		
Enabling the input of longer notes (tied notes) .....	18		
Recording parameter locking automation .....	18		
Recording parameter locking automation in real time .....	18		

# Preparing to play

## Part names

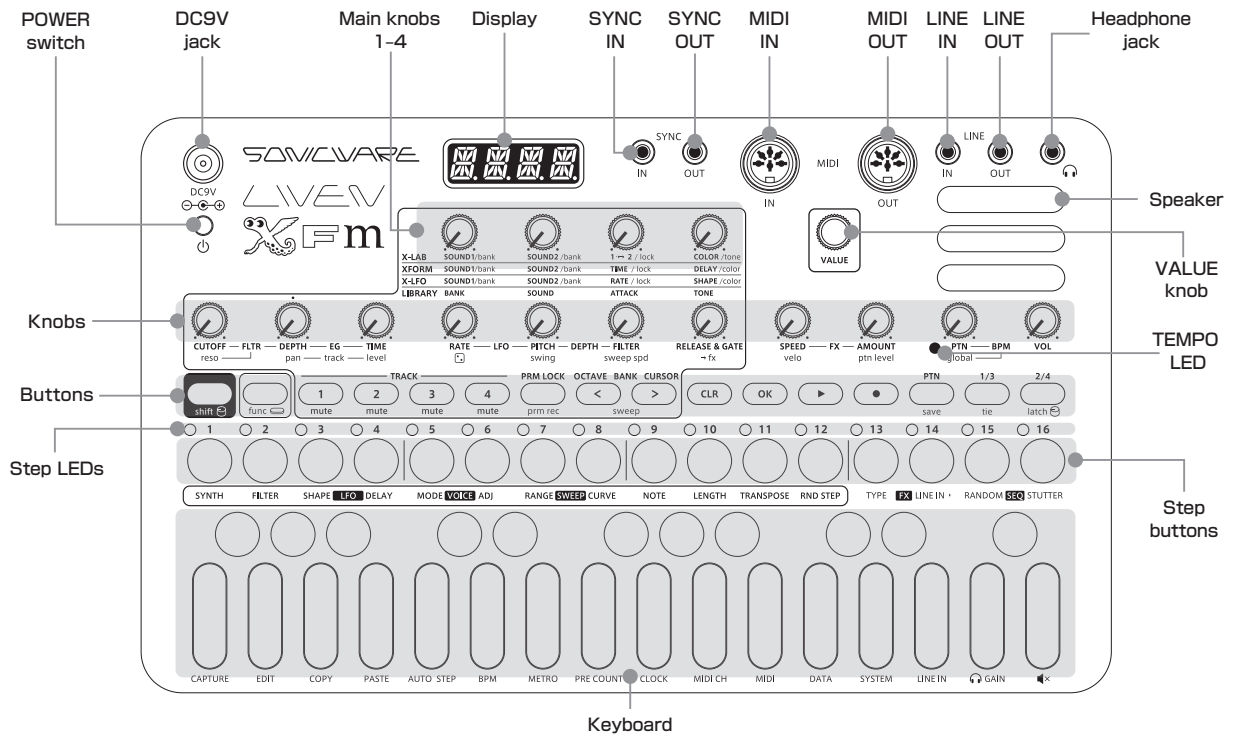

## Connecting

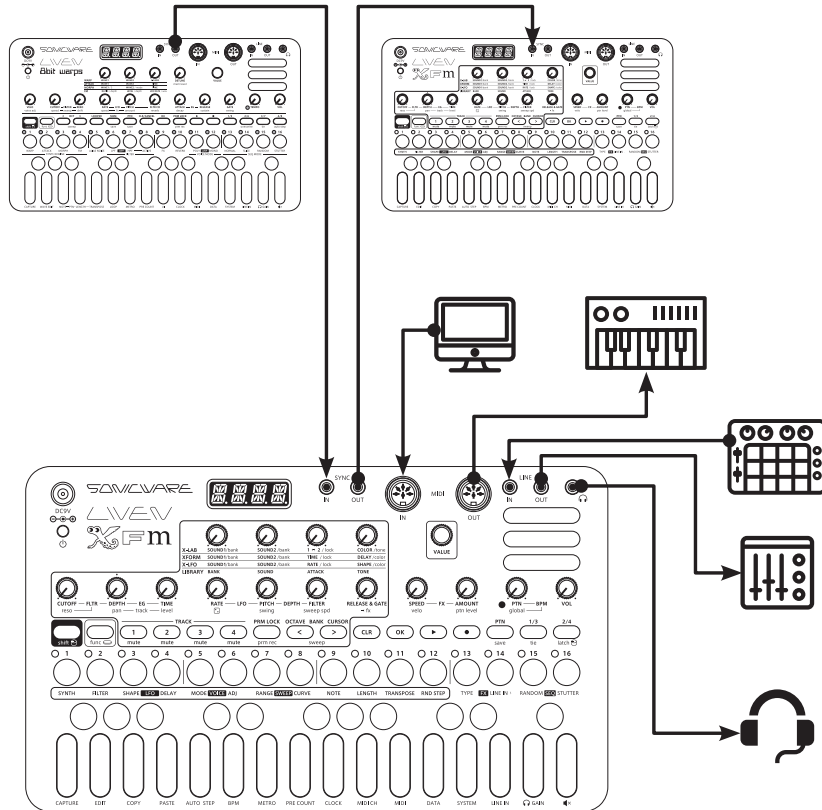

Note : Use cables that are 3 m or shorter.

# Preparing to play

## Preparing for startup

- ① Connect an AC adapter that conforms to the specifications (9V output, 1 A or more, EIAJ-03 standard, 1.7mm inner diameter, 4.75mm outer diameter, center +) to the DC9V jack on the LIVEN XFM.

**(Always use an AC adapter with these specifications. Using an AC adapter with different specifications could cause damage.)**

- ② Plug the AC adapter into an outlet.



- To power the LIVEN XFM using batteries, open the cover on the bottom and install 6 AA batteries.
- BT.LO will appear on the display at a regular interval if the remaining battery charge is low.
- BT.LO will appear on the display when starting up if the remaining battery charge is low.



- When BT.LO appears, replace the batteries right away.

## Starting up

- ① Press and hold the POWER switch to turn on the LIVEN XFM.

## Turning the unit off

- ① Press and hold the POWER switch to turn off the LIVEN XFM.



- Sound settings that have been edited will be lost when the power is turned off, so save them as necessary beforehand.

## Sound memories, tracks, and patterns

Sound memories save FM synthesizer sound settings.

Tracks save the sound memories they use, filter and other tone settings, sequences and other performance data.

Patterns save data for their four tracks and other pattern-related settings, including tempo and effects.

Up to 512 sound memories can be saved in 32

banks of 16.

Up to 128 patterns can be saved in 8 banks of 16.

When shipped new from the factory, preset sounds and sequences are saved in some sound memories and patterns.



- If a parameter being shown is the same as the original, a dot will appear at the bottom right of the display.

## Tracks

Patterns have four tracks, and different sounds can be set for each track. In addition, sequences can be created for each track.



- A maximum of six notes can be generated simultaneously (six-voice polyphony).
- If the maximum number of simultaneous notes is exceeded, notes will be turned off starting with tracks with the lowest priority. (If notes have been released, however, these notes will be turned off before other notes using the same track priority order.)
- The track priority order from high to low in is 4 > 3 > 2 > 1.

# Basic operations

This section explains basic operations.

## Adjusting the overall volume

- ① Turn the **VOL** knob.



- The level is shown on the display.
- This can be adjusted from  $-\infty$  to +6 dB with 0 dB as the middle value (63–64).
- The setting range is 0 – 127.

## Changing the octave range

- ① Press the **OCTAVE | BANK | CURSOR <** button to lower the octave by one. Press the **OCTAVE | BANK | CURSOR >** button to raise the octave by one.



- The octave can be raised or lowered by  $\pm 3$  from the standard octave.
- Depending on the octave, the **OCTAVE | BANK | CURSOR** cursor button changes to green ( $\pm 1$ ), orange ( $\pm 2$ ) or red ( $\pm 3$ ). (They are unlit when the octave has not been changed.)
- The octave is saved for each track.

## Basic knob operation

Turning a knob will change the parameter printed in uppercase letters.

Turning a knob while pressing the **SHIFT** will change the parameter printed in lowercase letters.



- **SHIFT** status can be held by pressing the **SHIFT** while pressing the **FUNC**. (Press the **SHIFT** again to stop holding.)

## Selecting and playing tracks

- ① Press a track button to select it. (The selected track button will light red.)

The buttons of tracks that are not selected light green (or orange when muted).

## Changing the velocity

- ① While pressing shift, turn the **VELO** knob.



- The parameter value is shown on the display.
- The setting range is 0 – 127.

## Sweeping notes while playing

- ① While pressing the **func** button, press the **OCTAVE | BANK | CURSOR <** button to sweep down or the **OCTAVE | BANK | CURSOR >** button to sweep up.



- Press the **OCTAVE | BANK | CURSOR** button again to turn sweep off. (The button will become unlit.)

- ② Play the keys.

- Patterns recorded with sweep active will also sweep during pattern playback.

## Holding notes

- ① Play a key while pressing the **OK** button to hold the note.



- Press the same key again to stop holding it.
- Press the **OK** button while pressing and holding the **CLR** button to stop holding notes for the selected track.
- During pattern playback, stopping will stop holding all notes.

## Changing step button parameters

- ① While pressing the **func** button, press the desired step button.



- The current setting value will be shown.
- Sequence mode settings will be reflected immediately.

- ② Press the step button repeatedly or turn the **VALUE** knob to change the parameter value.



- The parameter value is shown on the display.
- The **VALUE** knob cannot be used with STUTTER and RANDOM.

# Track settings

This section explains how to adjust track settings, including for the synth engine, filter, LFO, envelope generator (EG) and effects.

## Selecting tracks

- 1 Press the desired TRACK button.

The selected track button lights red.

The buttons of tracks that are not selected light green (or orange when muted).

The first 16 steps of the track sequence are shown by the step LEDs.



- The track number is shown on the display.
- The parameters shown in the blue areas on the top of the unit can be controlled separately for each track.

## Clearing all notes in a track

- 1 While pressing and holding , press a TRACK button to clear the notes on that track.



- The type of data to be cleared will be shown on the display.

- 2 Turn the  **VALUE** knob to select NOTE.
- 3 Press the  button.



- CLR will appear on the display.

## Restoring track sound settings to the last saved state

- 1 While pressing and holding , press the TRACK button for the track to be restored to saved sound settings.



- The type of data to be cleared will be shown on the display.



- 2 Turn the  **VALUE** knob to select SND.
- 3 Press the  button.



- CLR will appear on the display.
- When track sound settings are reloaded, the sound is restored to its last saved state.
- The following parameter changes are cleared.

1. All synth engine settings
2. Voice mode
3. All filter settings
4. All sweep settings
5. Track level
6. Panning
7. FX send level
8. All LFO settings
9. RELEASE & GATE
10. Swing

## Changing the synth engine

- 1 While pressing the , press the  button to select the synth engine.



- The synth engine name appears on the display.
- This can also be changed with the  **VALUE** knob.
- Four types of synth engines can be chosen.
  1. X-LAB (XLAB on display): This synth blends two sounds to create a new sound.
  2. XFORM (XFRM on display): This synth switches between two sounds after the set amount of time.
  3. X-LFO (XLFO on display): This synth morphs cyclically through two sounds.
  4. LIBRARY (LIB on display): This simple synth plays selected sounds.

## Adjusting synth engines

- 1 Turn  **main** knobs 1-4. (See "Table 1. Synthesizer engine parameter list" on p.36.)



- Parameter values are shown on the display.
- Turn these knobs while pressing and holding the  button to adjust other synth engine parameters.
- See the preset sound list (separate file) for details about the preset sounds.



# Track settings

## Changing the filter type

- ① While pressing the **func** button, press the **FILTER** button to select the type.

The **FILTER** LED will light.



- The filter type name is shown on the display.
- This can also be changed with the **VALUE** knob.
- Ten types of filters can be selected.
  1. **LPF.Λ** (LPΛ on display): This filter cuts high frequencies using an envelope with attack and decay.
  2. **LPF.!\\_** (LP!\\_ on display): This filter cuts high frequencies using an envelope with decay.
  3. **LPF./!\\_** (LP/!\\_ on display): This filter cuts high frequencies using an envelope with attack.
  4. **HPF.Λ** (HPΛ on display): This filter cuts low frequencies using an envelope with attack and decay.
  5. **HPF.!\\_** (HP!\\_ on display): This filter cuts low frequencies using an envelope with decay.
  6. **HPF./!\\_** (HP/!\\_ on display): This filter cuts low frequencies using an envelope with attack.
  7. **BPF.Λ** (BPΛ on display): This filter only allows frequencies in a specific range to pass using an envelope with attack and decay.
  8. **BPF./!\\_** (BP/!\\_ on display): This filter only allows frequencies in a specific range to pass using an envelope with decay.
  9. **BPF.!\\_** (BP!\\_ on display): This filter only allows frequencies in a specific range to pass using an envelope with attack.
  10. **OFF**: No filter is used.

## Changing the filter cutoff frequency

- ① Turn the **CUTOFF** knob.



- The parameter value is shown on the display.
- The setting range is 0 - 127.
- The frequency can be changed in a range of 70 - 21600 Hz.

## Adjusting the filter resonance

- ① While pressing the **shift** button, turn the **reso** knob.



- The parameter value is shown on the display.
- For **BPF**, this adjusts the width of the band.

- The setting range is 0 - 127.
- The resonance can be changed in a range of 0.1 - 10.
- For **BPF**, the bandwidth can be changed in a 0.1 - 2.0 octave range.

## Adjusting the filter envelope

- ① Turn the **DEPTH** and **TIME** knobs.



- The parameter value is shown on the display.
- The setting ranges are - 63 - +63 for **DEPTH** and 0 - 127 for **TIME**.
- The time can be changed in a range of 27 ms - 40 s.
- For **LPF.Λ**, **HPF.Λ** and **BPF.Λ**, **TIME** changes the attack and the decay.
- For **LPF.!\\_**, **HPF.!\\_** and **BPF.!\\_**, **TIME** changes the decay.
- For **LPF./!\\_**, **HPF./!\\_** and **BPF./!\\_**, **TIME** changes the attack.
- Filters of the same type (e.g. **LPF.Λ** and **LPF.!\\_**) share **DEPTH** and **TIME** settings.

## Changing the LFO type

- ① While pressing the **func** button, press the **SHAPE** **LFO** button, and select the LFO shape.



- The type is shown on the display.
- This can also be changed with the **VALUE** knob.
- Eight types of filters can be selected.
  1. **SINE** (sine wave)
  2. **SQAR** (square wave)
  3. **TRI** (triangle wave)
  4. **SAW** (sawtooth wave)
  5. **R.SAW** (reverse sawtooth wave)
  6. **RNDM** (random wave)
  7. **LOG** (logarithmic wave)
  8. **R.LOG** (reverse logarithmic wave)

## Changing the LFO starting delay

- ① While pressing the **func** button, press the **LFO** **DELAY** button, and change the delay time.



- The time is shown on the display.
- This can also be changed with the **VALUE** knob.

# Track settings

- The time can be changed in a range of 0 - 8000 ms.

## Adjusting the LFO speed

- ① Turn the **RATE** knob.



- The parameter value is shown on the display.
- The setting range is 0 - 127.
- The frequency can be changed in a range of 0.1 - 30 Hz.

## Adjusting the amount of LFO effect on pitch

- ① Turn the **PITCH** knob.



- The parameter value is shown on the display.
- The setting range is 0 - 127.
- This changes it in a range of - 2 - +2 octaves.

## Adjusting the amount of LFO effect on filter cutoff

- ① Turn the **FILTER** knob.



- The parameter value is shown on the display.
- The setting range is 0 - 127.
- This changes it in a range of 0 - 100%.

## Changing track note playback probability

- ① While pressing the **SHIFT** button, turn the **PROB** knob to set the probability.



- The probability is shown on the display.
- The setting range is 25 - 100.
- This changes it in a range of 25 - 100%.
- This only affects playback from the sequencer.

## Setting the level of track output sent to the effect

- ① While pressing the **SHIFT** button, turn the **FX** knob to set the send amount.



- The parameter value is shown on the display.
- The setting options are OFF and 1 - 127.
- This changes it in a range of 0 - 100%.
- For insert type effects, OFF enables direct output, while other settings disable direct output, sending the signal to the effect at 0 dB.

## Changing the sweep amount

- ① While pressing the **FUNC** button, press **RANGE SWEEP**, and set the sweep amount.



- The sweep amount is shown on the display.
- This can also be changed with the **VALUE** knob.
- The **RANGE SWEEP** amount can be set to 1 - 11 semitones or 1 - 2 octaves.
- Pressing the **RANGE SWEEP** button cycles through 1 semitone, 1 octave and 2 octave values.

## Changing the sweep speed

- ① While pressing the **SHIFT** button, turn the **SWEEP SPD** knob to set the sweep speed.



- The parameter value is shown on the display.
- The setting range is 0 - 31.

## Changing the sweep curve

- ① While pressing the **FUNC** button, press the **SWEEP CURVE** button, and set the sweep curve.



- The type is shown on the display.
- This can also be changed with the **VALUE** knob.
- Three types can be chosen.
  1. **LINEAR** (LINE on display): After input, the note changes linearly to the range amount.
  2. **EXP**: After input, the note changes gradually at first and then rapidly in the latter half to the range amount.
  3. **LOG**: After input, the note changes rapidly at first and then gradually slows to the range amount.

# Track settings

## Changing track pitch by semitone (transposing)

- ① While pressing the **func** button, press the **TRANSPOSE** button, and change the pitch.  
(This raises/lowers the key of the track in semitones.)



- The semitone change is shown on the display.
- The setting range is - 12 - +12 (in semitones).
- This is saved in the track settings.
- If the pitch is changed during pattern playback, the actual change of pitch will occur the next time the pattern begins.
- If transposition puts a note outside the 0-127 range, it will make no sound.

## Changing the voice mode

- ① While pressing the **func** button, press the **MODE VOICE** button, and select the voice mode.



- The voice mode name is shown on the display.
- This can also be changed with the **VALUE** knob.
- Four voice modes can be chosen.
  1. **POLY**: Up to six voices can be output simultaneously in this mode (voice priority increases in order from track 1 to 4)
  2. **MONO**: In this single voice mode, each note retriggers the sound.
  3. **LEGATO** (LGT on display): In this single voice mode, overlapping notes are not retriggered.
  4. **ARPEGGIATOR** (ARP on display): Pressed keys are played one at a time in this mode.

## Changing the legato speed

- ① While pressing the **func** button, press the **MODE VOICE** button, and select **MONO** or **LGT**.
- ② While pressing the **func** button, press the **VOICE ADJ** button, and set the speed.



- The parameter value is shown on the display.
- This can also be changed with the **VALUE** knob.
- The setting range is 0 - 127.
- The time can be changed in a range of 0 - 10000 ms.

## Changing the arpeggiator type

- ① While pressing the **func** button, press the **MODE VOICE** button, and select **ARP**.
- ② While pressing the **func** button, press the **VOICE ADJ** button, and select the arpeggiator type.



- The name of the type appears on the display
- This can also be changed with the **VALUE** knob.
- Twelve arpeggiator types can be selected.
  1. **UP**: Plays notes from lowest to highest repeatedly
  2. **DOWN**: Plays notes from highest to lowest repeatedly
  3. **UP DOWN** (UP.DN on display): Plays notes from lowest to highest to lowest to highest repeatedly
  4. **DOWN UP** (DN.UP on display): Plays notes from highest to lowest to highest to lowest repeatedly
  5. **UP & DOWN** (U.A.D on display): Plays notes from lowest to highest, then plays from highest to lowest, repeatedly
  6. **DOWN & UP** (D.A.U on display): Plays notes from highest to lowest, then plays from lowest to highest, repeatedly
  7. **RANDOM** (RNDM on display): Plays notes in random order
  8. **UP+1** (UP+1 on display): Plays notes from lowest to highest for 2 octaves repeatedly
  9. **UP+2** (UP+2 on display): Plays notes from lowest to highest for 3 octaves repeatedly
  10. **DOWN - 1** (DN-1 on display): Plays notes from highest to lowest for 2 octaves repeatedly
  11. **DOWN - 2** (DN-2 on display): Plays notes from highest to lowest for 3 octaves repeatedly
  12. **PLAY ORDER** (P.O on display): Plays notes in the order played on the keyboard

## Changing the track swing amount

- ① While pressing the **shift** button, turn the **swing** knob.



- The parameter value is shown on the display.
- The setting range is 0 - 75.
- This can be set in a range of 0 - 75%.

## Changing the track release and gate time

- ① Turn the **RELEASE & GATE** knob.

# Track settings



- Parameter values are shown on the display.
- The setting range is 0 - 127.
- From 85 - 127, the release time becomes longer as the value becomes higher. (100% and higher)
- From 42 - 84, the release time becomes shorter as the value becomes smaller. (Less than 100%)
- From 0 - 41, the gate time becomes shorter as the value becomes smaller. (10 - 90%)
- The gate time only affects sound from the sequencer.
- This setting is applied even when the voice mode is arpeggiator or the sequence mode is STUTTER.

## Changing track levels

- ① While pressing the button, turn the **track level** knob.



- The parameter value is shown on the display.
- The setting range is 0 - 127.
- This can be adjusted from  $-\infty$  to +6 dB with 0 dB as the middle value.

## Adjusting track panning

- ① While pressing the button, turn the **track pan** knob.



- The panning is shown on the display.
- The setting range is L63-CNTR-R63.

## Muting tracks

- ② While pressing the button, press a TRACK button to mute that track.

The TRACK button will light orange.



- MUTE will appear on the display.
- While pressing the func button, press the TRACK button again to stop muting it.

## Setting track MIDI channels

- ① While pressing the button, press the **MIDI CH** key and select T1.CH - T4.CH.

- ② Turn the **VALUE** knob to select the channel.



- The channel is shown on the display.
- The setting range is OFF and CH.01 - CH.16.
- The channel will be used for sending and receiving.
- By default, the channel numbers are the same as the track numbers.

## Copying tracks

- ① Select the pattern track to be copied.
- ② While pressing the button, press the **COPY** key.



- COPY will appear on the display.

- ③ Select the pattern track where the copied track will be pasted.
- ④ While pressing the button, press the **PASTE** key.



- DONE will appear on the display.





# Pattern playback and settings

This section explains how to play patterns and make settings for them.

## Pattern playback

- 1 Press the  button.



- Press the  button again to stop playback.
- At the playback position, the step LED will become lit if unlit or become unlit if lit.
- The 1/3 or 2/4 page button that corresponds to the current playback position will light red. The other page button will be lit green or orange.
- During pattern playback, press a page button to keep that page visible on the step buttons. That button will light red. Press the  button (or ,  or  button) to stop staying on that page. (When the playback position is on another page, that button will blink rapidly with the same color as when stopped. When the playback position is not on another page, that button will blink normally with the same color as when stopped.)
- The page buttons correspond to the steps as follows.

Steps 1–16:  button lit green

Steps 17–32:  button lit green

Steps 33–48:  button lit orange

Steps 49–64:  button lit orange

## Selecting patterns

- 1 Press the  button.



- The pattern number is shown.



- 2 Press the  buttons to select pattern banks.



- The banks number 1 – 8.

- 3 Press a step button to select a pattern (and end pattern selection mode).





- The  **VALUE** knob can also be turned to select patterns. (Press the  button to confirm.)
- Selecting the already selected pattern will reload it,

clearing edited settings.

- If you select a different pattern when the sequencer is playing, it will switch to the selected pattern after the current pattern is finished.



## Changing pattern volume

- 1 While pressing the  button, turn the  **ptn level** knob.



- The parameter value is shown on the display.
- The setting range is 0 – 127.
- This can be adjusted from  $-\infty$  to +6 dB with 0 dB as the middle value.

## Selecting multiple patterns and playing them in order (chain playback)

- 1 Press the  button twice (lights orange).
- 2 Press the  buttons to select pattern banks.
- 3 Press step buttons to select patterns in the order to be played.



The step LED for the selected pattern lights and its number is shown on the display.

- 4 Press the  button to play the patterns in the selected order.





- After the last pattern has played, that pattern will continue playing in a loop.
- Press the  button again to end chain playback.
- Press the step button for a selected pattern again to deselect it.
- STUTTER mode cannot be used during chain playback.

## Saving patterns

- 1 While pressing the  button, press the  button.
- 2 Use the  buttons to select the bank.
- 3 Press a step button to select the save destination.



- DONE will appear on the display.
- Press another mode button or the  or  button to cancel saving the patch memory.
- The  **VALUE** knob can also be turned to select

# Pattern playback and settings

save destination pattern numbers. (Press the  button to confirm.)



## Initializing patterns

- ① While pressing the  button, press the  button.



- When pattern initialization has completed,  will appear on the display.
- All pattern and track settings as well as note and parameter lock data will be cleared.





## Reloading patterns

- ① Press the  button.
- ② Press the  button or the step button that corresponds to the current pattern.



- When a pattern is reloaded, all pattern data is restored to the last saved state.
- When a pattern is reloaded while it is playing, it will be reloaded at the same time as the pattern change.

## Changing the effect type

- ① While pressing the  button, press the  button.
- ② Turn the  knob to select the effect.  
The  button lights when the effect is not OFF.



- The effect type name is shown on the display.
- Twelve types of effects can be chosen.
  1. OFF
  2. CHORUS (CHRS on display)
  3. FLANGER (FLNG on display)
  4. SEND DELAY (S.DLY on display)
  5. INSERT DELAY (I.DLY on display)
  6. CRUSH (CRSH on display)
  7. REVERB (RVB on display)
  8. MONO REVERB (M.RVB on display)
  9. DISTORTION (DIST on display)
  10. LOW PASS FILTER (LPF on display)
  11. HIGH PASS FILTER (HPF on display)
  12. ISOLATOR (ISO on display)
  13. TREMOLO (TRML on display)

- Effects include insert and send types. When insert effects are OFF, they are disabled and the sound is output directly. Otherwise, signals are sent to insert effects at 0 dB and not output directly.

Insert effects: I.DLY, CRSH, DIST, LPF, HPF, ISO, TRML

Send effects: CHRS, FLNG, S.DLY, RVB, M.RVB



## Changing effect parameters

- ① Turn the  **SPEED** and  **AMOUNT** knobs.



- The parameter value is shown on the display.
- The SPEED parameter changes the effect time, and the AMOUNT parameter changes the strength of the effect.
- The setting range is 0 - 127.

## Setting the sequencer mode

- ① While pressing the  button, press the  or  button to select the sequencer mode (selected sequencer mode lights).



- This mode can also be changed during playback.
- Two sequencer modes can be selected.

### 1. STUTTER mode

- In this mode, pressing step buttons plays the notes assigned to them in the selected track while sequencer playback continues. (Unselected tracks play normally.)
- Playback will occur normally when no step buttons are being pressed.
- When all step buttons are released, playback will continue from after the step that corresponds to the number of steps that have already played.

### 2. RANDOM mode

- In this mode, the sequencer plays randomly according to the RND STEP setting of each track. (See "Setting the track playback unit used during random playback" on p.19)
- Press the same sequence mode button again to resume normal playback. (Press the other sequence mode button to switch to that mode immediately.)

# Pattern playback and settings

## Setting pattern BPM

- ① Turn the **PTN BPM** knob.



- BPM will appear on the display.
- The setting range is 40 – 250.
- The TEMPO LED blinks in time with the set tempo.
- When the tempo is shown on the display, the **VALUE** knob can be turned to change it in 0.1-beat increments.

## Setting the global BPM

- ① While pressing the **shift** button, turn the **global BPM** knob.



- BPM will appear on the display.
- The setting range is 40 – 250.
- The TEMPO LED blinks in time with the set tempo.
- When the tempo is shown on the display, the **VALUE** knob can be turned to change it in 0.1-beat increments.

## Setting the BPM mode

- ① While pressing the **func** button, press the **BPM** key, and select PTN or GLBL.



- The mode is shown on the display.
- Two modes can be selected.
  1. **PATTERN** (PTN on display): The BPM set with the pattern is used.
  2. **GLOBAL** (GLBL on display): The global BPM is used.

## Adjusting the metronome volume

- ① Press the **METRO** key. (MTRO appears on the display.)
- ② Turn the **VALUE** knob to adjust the metronome volume.



- The metronome volume is shown on the display.
- The setting range is 0 – 15.

## Setting a pre-count

- ① While pressing the **func** button, press the **PRE COUNT** key.



- **PR.CT** will appear on the display.
- ② Turn the **VALUE** knob to change the pre-count.



- The count number is shown on the display.
- The setting options are OFF and 1 – 8.
- The volume of the pre-count is the same as for the metronome. (See “Adjusting the metronome volume” on p.15.)

## Changing pattern names

- ① While pressing the **func** button, press the **DATA** button, and select P.N.ED.



- The name of the pattern currently selected is shown on the display.

- ② Turn the **VALUE** knob to select the pattern name to edit.



- The **OCTAVE | BANK | CURSOR** and step buttons can also be used to select.

- ③ Press the **OK** button.

- ④ Input the name.



- Use the **OCTAVE | BANK | CURSOR** buttons to move the input position left and right. (Three dot positions occur between the four characters.)

- Turn the **VALUE** knob to select the character (or turn the dot on/off at a dot position).



- ⑤ Press the **OK** button to confirm the input and return to pattern selection.

# Pattern playback and settings

## Synchronizing the tempo with another device connected to the SYNC IN

- ① Connect the LIVEN XFM SYNC IN to the sync output of the connected device.
- ② Set the clock source to SYNC. (See "Setting the clock source" on p.33.)

## Synchronizing tempo with an ELZ\_1 or Pocket Operator (PO)

- ① Connect the LIVEN XFM headphone out to the ELZ\_1 AUX IN or PO input.
- ② While pressing the  button, press the  **CLOCK** key, and select A.OUT.
- ③ Turn the VALUE knob to select ON.



- A synchronization signal is output from the left channel of the headphone output.
- A mono mix signal is output from the right channel of the headphone output.
- CLOCK MENU

SRC	INT	MIDI/SYNC synchronization of external device using LIVEN XFM clock as master ( <b>Example 1</b> )
	MIDI	MIDI synchronization using external device clock as master
	SYNC	SYNC synchronization using external device clock as master ( <b>Example 2</b> )
	LN.IN	Audio SYNC synchronization using external device (Pocket Operator) clock as master ( <b>Example 3</b> ) Synchronization signal input on left channel of LIVEN XFM LINE IN, mono signal input on right channel
A.OUT	Turn this on when connecting LIVEN XFM to ELZ_1 or Pocket Operator using Audio SYNC ( <b>Example 4</b> )	

## Examples of synchronization connections with external devices

### Example 1 : LIVEN XFM as master synchronizes external device

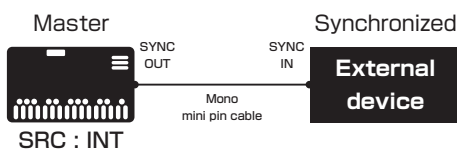

### Example 2 : External device as master synchronizes with LIVEN XFM

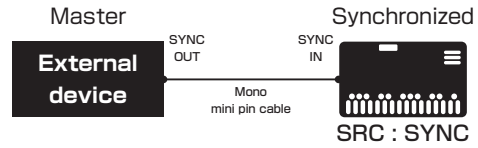

### Example 3 : Pocket Operator as master synchronizes LIVEN XFM

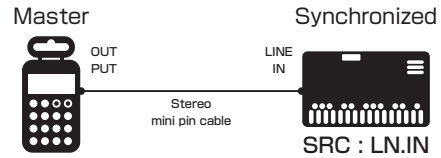

### Example 4 : LIVEN XFM as master synchronizes with ELZ\_1 or Pocket Operator

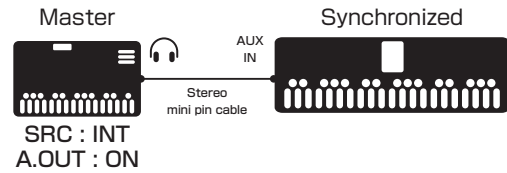





# Track sequencing

This section explains sequence input and settings for individual tracks.

## Step recording

- 1 Press the  button (lights red).

The LED for the current step will blink. The LEDs for steps that already have notes will light.

- 2 Press the  or  button to select the page. (The button for the selected page will light red.)



- The pattern length corresponds to page buttons as follows.

1 - 16  button lit green

17 - 32  button lit green

33 - 48  button lit orange

49 - 64  button lit orange

- Page buttons are enabled or disabled according to the length of the pattern.

- 3 Press the step button for the position to input.

The input note sounds (continuously with sustain), and the step LED blinks.



- The  **VALUE** knob can also be turned to change the step position. (Step notes will sound during movement).

- 4 Play notes on the keyboard.

The notes of keys pressed sound (continuously with sustain).



- Playing the same note that has already been input on the step will clear it.
- By pressing a different step button while continuing to hold a keyboard key, notes can be input on all the steps in between. (Changing pages is also possible.) If tie is enabled, a tied note will be input between the steps. (If the same note already exists on a step of the tied note, it will be overwritten.)
- While pressing and holding , press a step button to delete note and parameter lock data for that step. (If that step includes a tied note, the entire tied note will be deleted. It will not be divided.)
- When AUTO STEP is ON, after all keyboard keys are released, the sequencer will advance to the next step, and the note on that step will sound.
- When sound locking is activated, playing keyboard

keys will overwrite notes on steps. (See “Recording sound locking automation to steps” on p.18.)

- Notes cannot be tied from the last page to the first page.
- During tied note input, if a step in a position earlier than the current step is pressed, it will be reversed.
- The CLR button can be used even when not recording.

## Copying and pasting steps during step recording

- 1 Press the  button (lights red).

The LED for the current step will blink. The LEDs for steps that already have notes will light.

- 2 Press the button for the step to be copied.

The LED for the selected step will blink.

- 3 While pressing the , press the  **COPY** key.



- COPY will appear on the display.

- 4 Press the button for the paste destination step.

- 5 While pressing the , press the  **PASTE** key.



- DONE will appear on the display.
- Tie data will not be copied.



## Automatically advancing steps during step recording (auto step mode)

- 1 While pressing the , press the  **AUTO STEP** key, and select ON or OFF.



- ON or OFF will appear on the display.



## Recording in real time

- 1 After pressing the , press the .
- 2 While the pattern is playing back, play the keyboard at the desired input times.



- If a pre-count has been set, playback will start after the pre-count. (The pre-count will be shown on the display.)

# Track sequencing

- To input tied notes, while pressing the  button, press the  button to enable the tie function.
- When sound locking is activated, playing keyboard keys will overwrite notes on steps. (See “Recording sound locking automation to steps” on p.18.)

## Directly inputting notes on steps

- ① Press  or  to select the page.



- During pattern playback, press a page button to lock to that page. Press  to unlock.

- ② Press and hold the button for the step that you want to add a note to.
- ③ Play notes on the keyboard.





- Notes can also be directly input on steps by pressing step buttons while playing the keyboard.

## Enabling the input of longer notes (tied notes)

- ① While pressing the  button, press the  button to turn it on (lit red).

## Recording parameter locking automation

- ① Select the track on which you want to record parameter operations.
- ② Press  or  to select the page.



- During pattern playback, press a page button to lock to that page. Press  to unlock.



- ③ Press and hold the button for the step on which you want to change a parameter.
- ④ Use the knobs to change parameters.



- After parameters have been recorded, this data will not be saved if the pattern is not saved.
- Parameters cannot be recorded in STUTTER mode.
- FX SPEED, FX AMOUNT, ptn level, velo, PTN BPM and global BPM cannot be parameter locked.
- Multiple step parameters cannot be changed

simultaneously.

## Recording parameter locking automation in real time



- ① Select the track on which you want to record parameter operations.
- ② While pressing the  button, press the  button (lights red).
- ③ Press the  button to play the pattern.





- If a pre-count has been set, playback will start after the pre-count. (The pre-count will be shown on the display.)

- ④ Use the knobs to change parameters.

## Recording sound locking automation to steps

- ① Select the track on which you want to record the current sound.
- ② Press  or  to select the page.
- ③ Press the  button twice (lights orange).
- ④ Press and hold the button for the step on which you want to input the current sound.
- ⑤ Play notes on the keyboard.



- Locking works the same way when step recording.
- During real-time recording, notes input with the current sound (parameter lock data) are also recorded. (Only synth engine parameter data is recorded. Filter, LFO and sweep parameters, as well as , swing, track pan, track level, RELEASE & GATE and  fx data is not recorded.)
- Notes will be overwritten during recording.

## Turning parameter locking automation on/off

- ① Select the track on which parameter locking will be turned on/off. (See “Selecting tracks” on p.8.)
- ② Press the  button.

This lights green when parameter locking is on and orange when both parameter and sound locking are on. When neither are on, it is unlit.

When parameter locking is on, recorded parameter lock data is applied to change parameters.

# Track sequencing

## Initializing parameter lock automation

- ① Select the pattern on which to clear parameter locks. (See "Selecting patterns" on p.13.)
- ② Select the track on which to clear parameter locks. (See "Selecting tracks" on p.8.)
- ③ Press and hold the CLR button.
- ④ Press the PRM LOCK button.



- When parameter lock data initialization has completed, CLR will appear on the display.

## Clearing note and parameter lock automation data

- ① While pressing the CLR button, press a step to clear its note and parameter data.



- While pressing the CLR button, steps that have parameter lock data blink.
- When recording notes (REC button lit red), only notes will be cleared.
- When recording parameters (PRM LOCK button lit red), only parameter data will be cleared.
- Normally, when the REC and PRM LOCK buttons are lit red, note and parameter data will be cleared.

## Changing the track length

- ① While pressing the func button, press the LENGTH button.
- ② Turn the VALUE knob to change the length.



- The length is shown on the display.
- The setting range is 1 - 64.
- Pressing the LENGTH button cycles through lengths of 16, 32, 48 and 64 steps.
- Playback will loop using the set number of steps for each track.

## Changing the note length of a single step

- ① While pressing the func button, press the NOTE button.
- ② Turn the VALUE knob to change the note length.



- The note length is shown on the display.

- Notes can be set to 1/1, 1/2, 1/4, 1/4, 1/8, 1/2T, 1/8, 1/16, 1/4T, 1/16, or 1/32. ( "." indicates a dotted note, and "T" indicates a triplet length.)

## Setting the track playback unit used during random playback

- ① While pressing the func button, press the RND STEP button (lights unless OFF).
- ② Turn the VALUE knob to change the playback unit.





- The playback unit is shown on the display.
- The set playback unit will be used for random playback.
- The setting options are OFF, 1, 2, 4, 8 and 16.
- Playback will include all steps.
- If set to OFF, the track will not be played randomly even when the sequence mode is set to RANDOM.

# Sound editing



This section explains how to create and edit sounds.

## Editing sounds

- 1 While pressing the  button, press the  **EDIT** key, and use the included sound editing panel overlay.

The step LED for the selected sound will light.



- The name of the current bank is shown on the display.
- When in sound editing mode, patterns cannot be played back.
- Play the keyboard to hear the selected sound.
- While pressing the  button, press the  buttons to change octaves.

- 2 Press the  buttons to select the bank.





- There are 32 banks.
- The bank name appears temporarily on the display.
- The potentiometer  **VALUE** knob can also be turned to select banks.

- 3 Turn the  **VALUE** knob to select a sound.



- Sounds can also be selected by pressing the step buttons.
- The sound name appears on the display.

- 4 Press the  button to enter sound editing mode.

The selected  and  buttons light.



- 5 Adjust parameters. (For details, see “Editing sound parameters” .)





- Parameter values are shown on the display.
- “----” appears for buttons that do not affect parameter adjustment.
- The EDITED LED lights when values differ from saved values.

- 6 When done editing parameters, press the  button.

The step LED for the selected sound will light.

- 7 Use the  buttons and  **VALUE** knob to select the save destination.





- The save location can also be selected by pressing a step button.
- The bank name is shown on the display while an  button is being pressed.
- The sound name is shown on the display while the  **VALUE** knob is being turned.
- The sound of the save destination can be checked by playing the keyboard while pressing the  button.

- 8 Press the  button.

- 9 Input the name. (The character at the current position blinks.)



- Use the  buttons to move the input position left and right. (Three dot positions occur between the four characters.)
- Turn the  **VALUE** knob to select the character (or turn the dot on/off at a dot position).
- Uppercase alphabet letters and numbers can be used.

- 10 Press the  button to save the sound and end sound editing mode.



## Clearing sounds

- 1 Follow steps 1 - 4 in “Editing sounds” .
- 2 Press the  button.



- INIT will appear on the display.
- The selected sound will be set to default values.
- The sound can be further edited after this.

## Copying sounds

- 1 Follow steps 1 - 4 in “Editing sounds” .
- 2 Press the  button.
- 3 Use the  buttons and  **VALUE** knob to select the number of the sound to be copied.

# Sound editing



- The save destination can also be selected by pressing a step button.
- The bank name is shown on the display while an **OCTAVE | BANK | CURSOR** button is being pressed.
- The sound name is shown on the display while the **VALUE** knob is being turned.
- The sound of the copy source can be checked by playing the keyboard while pressing the **SHIFT** button.

- ④ Press the **OK** button to copy the sound and start sound editing mode.

## Changing sound names

- ① Follow steps ① - ④ in "Editing sounds" .
- ② Press the **EDIT NAME** button.
- ③ Input the name.



- Use the **OCTAVE | BANK | CURSOR** buttons to move the input position left and right. (Three dot positions occur between the four characters.)
- Turn the **VALUE** knob to select the character (or turn the dot on/off at a dot position).
- Uppercase alphabet letters and numbers can be used.

- ④ Press the **OK** button to save the name change and return to sound editing mode.

## Changing sound bank names

- ① Follow steps ① - ② in "Editing sounds" .
- ② Press the **EDIT NAME** button.
- ③ Input the name.



- Use the **OCTAVE | BANK | CURSOR** buttons to move the input position left and right. (Three dot positions occur between the four characters.)
- Turn the **VALUE** knob to select the character (or turn the dot on/off at a dot position).
- Uppercase alphabet letters and numbers can be used.

- ④ Press the **OK** button to save the name change and return to sound selection.

## Capturing synth engine sounds

### (capture mode)

- ① While pressing the **FUNC** button, press the **CAPTURE** key.



- Capture mode can only be enabled when the synth engines are X-LAB and LIBRARY.
- CPTR will appear on the display.

- ② Use the **OCTAVE | BANK | CURSOR** buttons and **VALUE** knob to select the save destination.



- The save destination can also be selected by pressing a step button.
- The bank name is shown on the display while an **OCTAVE | BANK | CURSOR** button is being pressed.
- The sound name is shown on the display while the **VALUE** knob is being turned.
- The sound of the save destination can be checked by playing the keyboard while pressing the **SHIFT** button.
- While pressing the **FUNC** button, press the **OCTAVE | BANK | CURSOR** buttons to change octaves.

- ③ Press the **OK** button to return to normal mode.



- Press the CLR button to cancel saving.
- The captured sound might be slightly different from the original sound.

# Creating sounds with operators using the editing overlay

This section explains how to edit sound parameters.

Use the included sound editing panel overlay when editing.

Explanations assume that sound editing mode has already been enabled

Follow steps ① - ④ in "Editing sounds" to activate sound editing mode.

- In sound editing mode, the **OCTAVE | BANK | CURSOR** buttons function as octave buttons.
- The voice mode can be changed by pressing the play button.
- The page 2 adj knob can be used to adjust the voice mode (legato speed)

## Selecting the operator to edit

- ① Press the OPERATOR button for the operator to edit.

The selected OPERATOR button lights red.



- The step buttons enclosed in the orange line are parameters that can be used to control each oscillator and the mixer separately.
- In the QUICK EDIT area, regardless of the selected operator, parameters for each operator can be changed directly.
- If a step button that cannot be controlled or does not have parameters is pressed, "----" will appear on the display.

## Muting operators

- ① Press the OPERATOR button for the selected operator.

The OPERATOR button will light orange (or red when selected).



- OFF will appear on the display.
- Pressing the OPERATOR button of a muted operator will select it. Pressing the button again will stop muting the operator. (ON will appear on the display.)
- The operators are only muted during sound editing, and the mute setting is not saved.

## Setting connection levels and feedback between operators

- ① Press an OPERATOR button to select that operator.

- ② Press the **PAGE1** button.

- ③ Press an OP/MIXER RECEIVE LEVEL **OP** 1 - 4 button.  
The OP/MIXER RECEIVE LEVEL **OP** 1 - 4 LED lights.



- The setting value is shown on the display.

- ④ Turn the **VALUE** knob to set the connection level of the operator selected in step ①.



- The level is shown on the display.
- When the connection source and connection destination are different operators, the setting range is 0 - 127. When they are the same operator, the range is -63.0 - +64.0.
- Setting values higher than 63.0 will gradually increase noise.
- This is the feedback value for connections to the same operator (for example, setting the OP1 connection level when operator 1 is selected).
- When the feedback is negative, the sound will change to contain increasingly more odd harmonics.
- Feedback can also be set by turning the **fb** knobs (page 2) of each operator.
- Both the encoder and potentiometer **VALUE** knobs can be used. (With feedback, the encoder type knob adjusts in 0.1 increments while the potentiometer type knob adjusts in 1.0 increments.)

## Setting operator ratios

- ① Press an OPERATOR button to select that operator.

- ② Press the **PAGE1** button.

- ③ Press the **RATIO/FREQ** button.  
The **RATIO/FREQ** LED will light.



- The setting value is shown on the display.

- ④ Turn the **VALUE** knob to set the ratio.



- The ratio is shown on the display with a decimal point.
- The setting range is 0.5 - 32 in 0.01 steps.
- This can also be set by turning the **RATIO** and **FINE** knobs of each operator. (The **RATIO** knob

# Creating sounds with operators using the editing overlay

can only change the value to 0.5 or a whole number, while the **FINE** knob can change it by decimal values.)

- Both the encoder and potentiometer **VALUE** knobs can be used.

## Setting operator levels

- ① Press an OPERATOR button to select that operator.
- ② Press the **PAGE1** button.
- ③ Press the **LEVEL** button.  
The **LEVEL** LED will light.



- The setting value is shown on the display.
- This can also be set by turning the **level** knobs (page 2) of each operator.

- ④ Turn the **VALUE** knob to set the level.



- The level is shown on the display.
- The setting range is 0 - 127.
- The value can be set from  $-\infty$  to +6 dB (63 is 0 dB).
- Both the encoder and potentiometer **VALUE** knobs can be used.

## Setting operator detuning

- ① Press an OPERATOR button to select that operator.
- ② Press the **PAGE1** button.
- ③ Press the **DETUNE** button.  
The **DETUNE** LED will light.



- The setting value is shown on the display.

- ④ Turn the **VALUE** knob to set the detuning.



- The detuning is shown on the display.
- The setting range is - 63 - +63.
- This can also be set by turning the **detune** knobs (page 2) of each operator.
- Both the encoder and potentiometer **VALUE** knobs can be used.

## Setting operators to fixed mode

- ① Press an OPERATOR button to select that operator.
- ② Press the **PAGE2** button.
- ③ Press the **FIXED** button.  
The **FIXED** LED will light.



- The setting value is shown on the display.

- ④ Turn the **VALUE** knob to turn this ON/OFF.



- ON or OFF will appear on the display.
- When ON, the operator will output the set frequency regardless of input notes.
- Both the encoder and potentiometer **VALUE** knobs can be used.

## Setting the frequency when in fixed mode

- ① Press an OPERATOR button to select that operator.
- ② Press the **PAGE1** button.
- ③ Press the **RATIO/FREQ** button.  
The **RATIO/FREQ** LED will light.



- The setting value is shown on the display.

- ④ Turn the **VALUE** knob to set the frequency.



- The frequency is shown on the display.
- The setting range is 1.0 - 9831 Hz.
- This can also be set by turning the **RATIO/FREQ** and **FINE** knobs of each operator.
- Both the encoder and potentiometer **VALUE** knobs can be used.

## Setting operator envelopes

- ① Press an OPERATOR button to select that operator.
- ② Press the **PAGE1** or **PAGE2** button.



- Press **PAGE1** for LEVEL settings and **PAGE2** for time

# Creating sounds with operators using the editing overlay

settings.

- ③ Press an envelope generator button.  
The LED for that envelope generator button will light.



- The setting value is shown on the display.

- ④ Turn the **VALUE** knob to set the envelope value.



- The level or time is shown on the display.
- The setting range is 0 - 127.
- Both the encoder and potentiometer **VALUE** knobs can be used.
- When A LEVEL is set to 0, after playing a key and the set time elapses, decay will begin.
- Although these are labeled ADSR, the LEVEL values can be set freely, so envelopes with a variety of shapes can be set.

## Setting operator envelope curves

- ① Press an OPERATOR button to select that operator.
- ② Press the **page2** button.
- ③ Press the **up cv** or **down cv** button.  
The **up cv** or **down cv** button LED will light.



- The setting value is shown on the display.

- ④ Turn the **VALUE** knob to set the curve.



- The curve is shown on the display.
- The setting range is - 18 - +18.
- As the number increases in the negative direction, the envelope curve takes effect faster.
- As the number increases in the positive direction, the envelope curve takes effect slower.
- At 0 the envelope curve becomes linear.
- Both the encoder and potentiometer **VALUE** knobs can be used.

## Turning the pitch envelope on/off

- ① Press an OPERATOR button to select that operator.

- ② Press the **page2** button.
- ③ Press the **page** button.  
The **page** LED will light.



- The setting value is shown on the display.

- ④ Turn the **VALUE** knob to turn it on or off.



- ON or OFF will appear on the display.
- Both the encoder and potentiometer **VALUE** knobs can be used.

## Setting the pitch envelope

- ① Press the **MIXER** button.
- ② Press the **PAGE1** or **page2** button.



- Press PAGE 1 for LEVEL settings and page 2 for time settings.

- ③ Press an **envelope generator** button.



- The setting value is shown on the display.

- ④ Turn the **VALUE** knob to set the envelope value.



- The level or time is shown on the display.
- The LEVEL setting range is - 48 - +48.
- The time setting range is 0 - 127.
- Both the encoder and potentiometer **VALUE** knobs can be used.
- When A LEVEL is set to 0, after playing a key and the set time elapses, decay will begin.
- Although these are labeled ADSR, the LEVEL values can be set freely, so envelopes with a variety of shapes can be set.

## Setting the operator keyboard gain scaling depths (left/right)

- ① Press an OPERATOR button to select that operator.
- ② Press the **PAGE1** button.



# Creating sounds with operators using the editing overlay

- ③ Press the or button.  
The or LED will light.



- The setting value is shown on the display.

- ④ Turn the knob to set the depth.



- The depth is shown on the display.
- The setting range is - 63 - +63.
- Both the encoder and potentiometer knobs can be used.

## Setting the operator keyboard gain scaling curves (left/right)

- ① Press an OPERATOR button to select that operator.  
② Press the button.  
③ Press the or button.  
The or LED will light.



- The setting value is shown on the display.

- ④ Turn the knob to select the curve.



- The curve is shown on the display.
- Two curve types can be chosen.
  1. LINEAR(LINE on display)
  2. EXPONENTIAL (EXP on display)
- Both the encoder and potentiometer knobs can be used.

## Setting the operator keyboard gain scaling position

- ① Press an OPERATOR button to select that operator.  
② Press the button.  
③ Press the button.  
The LED will light.



- The setting value is shown on the display.

- ④ Turn the knob to set the scaling position.



- The scaling position is shown on the display.
- Seven scaling positions can be selected: C1, C2, C3, C4, C5, C6 and C7.
- Both the encoder and potentiometer knobs can be used.

## Setting operator velocity sensitivity

- ① Press an OPERATOR button to select that operator.  
② Press the button.  
③ Press the button.  
The LED will light.



- The setting value is shown on the display.
- ④ Turn the knob to set the velocity sensitivity.



- The sensitivity is shown on the display.
- The higher the value, the more velocity will affect the operator level.
- The setting range is 0 - 127.
- Both the encoder and potentiometer knobs can be used.

## Setting the operator keyboard time scaling

- ① Press an OPERATOR button to select that operator.  
② Press the button.  
③ Press the button.  
The LED will light.



- The setting value is shown on the display.

- ④ Turn the knob to set how much keyboard scaling affects time.



- The parameter value is shown on the display.
- The higher the value, the more envelope time is lengthened for low notes and shortened as notes become higher.

# Creating sounds with operators using the editing overlay

- The setting range is 0 - 127.
- Both the encoder and potentiometer  $\ominus$  **VALUE** knobs can be used.

## Setting operator to mixer connection levels

- 1 Press the  $\text{MIXER}$  button.
- 2 Press the  $\text{PAGE1}$  button.
- 3 Press an  $\text{OP/MIXER RECEIVE LEVEL}_{\text{OP } 1-4}$  button.  
The  $\text{OP/MIXER RECEIVE LEVEL}_{\text{OP } 1-4}$  LED lights.



- The setting value is shown on the display.

- 4 Turn the  $\ominus$  **VALUE** knob to set the connection level of the operator to the mixer.



- The level is shown on the display.
- The setting range is 0 - 127.
- This can be adjusted from  $-\infty$  to 0 dB.
- This can also be set by turning the  $\ominus$  **MIXER RECEIVE LEVEL}\_{\text{OP } 1-4} knobs.**
- Both the encoder and potentiometer  $\ominus$  **VALUE** knobs can be used.

## Setting the mixer output level

- 1 Press the  $\text{MIXER}$  button.
- 2 Press the  $\text{PAGE1}$  button.
- 3 Press the  $\text{LEVEL}$  button.  
The  $\text{LEVEL}$  LED will light.



- The setting value is shown on the display.

- 4 Turn the  $\ominus$  **VALUE** knob to set the MIXER output level.



- The level is shown on the display.
- The setting range is - 63 - +63.
- This changes it in a range of - 12 - +12 dB.

## Selecting algorithms and setting operator connections

- 1 While pressing the  $\text{PAGE1}$  button, press the  $\text{PAGE2}$  button.

The  $\text{PAGE1}$  and  $\text{PAGE2}$  buttons will light.



- The setting value is shown on the display.
- The setting range is AL01-AL16.

- 2 Turn the  $\ominus$  **VALUE** knob to select the algorithm.





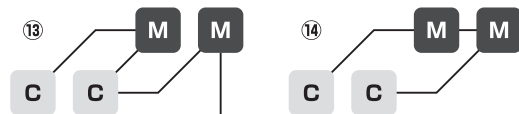

- The algorithm number is shown on the display
- The following 16 algorithm types can be selected. (  $\text{C}$  is "carrier" and  $\text{M}$  is "modulator" with OP1 to OP4 shown in order from left to right.)



# Creating sounds with operators using the editing overlay

---

- Both the encoder and potentiometer  **VALUE** knobs can be used.
- Press the ,  or  button to end algorithm selection.

- ③ Press the  button to select the algorithm and end algorithm selection.

## Changing the voice mode and playing during sound editing

- ① Press the VOICE MODE button to select the voice mode.



- The mode is shown on the display.
- 3 voice modes can be chosen.
  1. **POLY**: Up to 6 voices can be output simultaneously in this mode
  2. **MONO**: In this single voice mode, each note retriggers the sound.
  3. **LEGATO** (LGT on display): In this single voice mode, overlapping notes are not retriggered.
- The legato time can be changed using page 2 adj.

# External input settings

---



This section explains settings related to external input.

## Changing the FX send amount



- ① While pressing the  button, press the  button, and set the send amount.

The  LED will light for any setting other than OFF.



- The send amount is shown on the display.
- This can also be changed with the  **VALUE** knob.
- The setting options are OFF and 1 - 127.
- Pressing the  button cycles through OFF, 10, 30, 50, 70, 90, 110 and 127 values.



## Changing the gain

- ① While pressing the  button, press the  **LINE IN** button, and select GAIN.
- ② Turn the  **VALUE** knob to change the gain.



- The gain is shown on the display.
- The setting range is 0 - 127.
- This can be adjusted from  $-\infty$  to +6 dB.
- 90 is 0 dB.
- When using an insert effect that is OFF, it will be disabled and the sound output directly. Otherwise, signals are sent to the insert effect at 0 dB and not output directly.



## Setting mono/stereo

- ① While pressing the  button, press the  **LINE IN** button, and select MONO.
- ② Turn the  **VALUE** knob to turn this ON/OFF.

# MIDI settings

This section explains settings related to MIDI.



## Setting track MIDI channels

- ① While pressing the  button, press the  **MIDI CH** key, and select T1.CH - T4.CH.
- ② Turn the  **VALUE** knob to set the channel.



- The channel is shown on the display.
- The setting range is OFF and CH.01 - CH.16.
- The channel will be used for sending and receiving.



## Setting the MIDI channels for pattern parameters

- ① While pressing the  button, press the  **MIDI CH** key, and select PT.CH.
- ② Turn the  **VALUE** knob to set the channel.



- The channel is shown on the display.
- The setting range is OFF and CH.01 - CH.16.
- The channel will be used for sending and receiving.



## Setting the MIDI channel for accessing the active track (auto channel)

- ① While pressing the  button, press the  **MIDI CH** key, and select AT.CH.
- ② Turn the  **VALUE** knob to set the channel.



- The channel is shown on the display.
- The setting range is OFF and CH.01 - CH.16.
- The channel will be used for sending and receiving.



## Setting the output channel

- ① While pressing the  button, press the  **MIDI CH** key, and select O.CH.
- ② Turn the  **VALUE** knob to select the channel to use.



- The channel is shown on the display.
- The setting options are TRCK and AUTO.



## Setting the program change channel

- ① While pressing the  button, press the  **MIDI CH** key, and select PC.CH.
- ② Turn the  **VALUE** knob to change the program change channel.



- The channel is shown on the display.
- The setting options are AUTO and CH.01-CH.16.



## Turning control change transmission on/off

- ① While pressing the  button, press the  **MIDI** key, and select TX.CC.
- ② Turn the  **VALUE** knob to turn this ON/OFF.



- ON/OFF will appear on the display.
- Control change reception is always enabled.



## Turning MIDI clock output on/off

- ① While pressing the  button, press the  **MIDI** key, and select TX.CK.
- ② Turn the  **VALUE** knob to turn this ON/OFF.



- ON/OFF will appear on the display.



## Setting MIDI OUT

- ① While pressing the  button, press the  **MIDI** key, and select M.OUT.
- ② Turn the  **VALUE** knob, and set MIDI OUT.



- OUT/THRU will appear on the display.

## Setting MIDI command receipt and transmission

- ① While pressing the  button, press the  **MIDI** key, and select M.CMD.
- ② Turn the  **VALUE** knob, and select the MIDI command setting.





- The setting is shown on the display.

# MIDI settings

- 4 settings can be chosen.
  1. OFF: Neither transmit nor receive
  2. RX: Only receive
  3. TX: Only transmit
  4. RX.TX: Transmit and receive



## Turning active sensing transmission on/off

- ① While pressing the  button, press the  **MIDI** key, and select TX.AS.
- ② Turn the  **VALUE** knob to turn this ON/OFF.



- ON/OFF will appear on the display.



## Turning active sensing reception on/off

- ① While pressing the  button, press the  **MIDI** key, and select RX.AS.
- ② Turn the  **VALUE** knob to turn this ON/OFF.



- ON/OFF will appear on the display.



## Turning program change transmission on/off

- ① While pressing the  button, press the  **MIDI** key, and select TX.PC.
- ② Turn the  **VALUE** knob to turn this ON/OFF.



- ON/OFF will appear on the display.
- When a new pattern is selected, and the sequencer is stopped, a MIDI program change message will be sent instantly which corresponds with the new pattern number.
- When a new pattern is selected, and the sequencer is playing, a MIDI program change message will be sent after the current pattern ends and the new pattern starts.

## Turning program change reception on/off

- ① While pressing the  button, press the  **MIDI** key, and select RX.PC.
- ② Turn the  **VALUE** knob to turn this ON/OFF.



- ON/OFF will appear on the display.
- When a program change message is received, it switches to the pattern of the received number.

# Saving and loading user data

This section explains ways to save and load user data.

User data can be saved and loaded via MIDI. Connect a device that can transmit and receive data by MIDI to the LIVEN XFM.

## Exporting pattern data

- ① Select the pattern you want to export. (See “Selecting patterns” on p.13.)
- ② While pressing the **func** button, press the **DATA** key, and select P.EXP.
- ③ Turn the **VALUE** knob to select PTN.
- ④ Press the **OK** button to start transmission.



- Regardless of data transmission status, the **CLR** button can be pressed to cancel.
- After transmission completes, DONE will appear on the display and normal mode will resume.

## Exporting sound data

- ① Enter sound editing mode and select the sound you want to export. (See “Editing sounds” steps ① - ④ on p.20.)
- ② Press the **MIDIEXPORT** button to start transmission.



- Regardless of data transmission status, the **CLR** button can be pressed to cancel.
- After transmission completes, DONE will appear on the display and sound editing mode will resume.

## Exporting sound banks

- ① Enter sound editing mode and select the bank you want to export. (See “Editing sounds” steps ① - ② on p.20.)
- ② Press the **MIDIEXPORT** button to start transmission.



- Regardless of data transmission status, the **CLR** button can be pressed to cancel.
- After transmission completes, DONE will appear on the display and bank selection status will resume.

## Importing pattern data

- ① Put the unit into normal mode, and start transmitting data from the transmitting device.



- After reception completes, the received pattern data will be applied to the current pattern. (It will not be saved.)
- Save the received pattern data if necessary.

## Importing sound data

- ① Enter sound editing mode and select the import destination sound. (See “Editing sounds” steps ① - ④ on p.20.)
- ② Start transmitting data from the transmitting device.



- After reception completes, the received sound data will be applied to the current sound (It will not be saved.)
- Save the received sound data if necessary.

## Importing sound banks

- ① Enter sound editing mode and select the import destination bank. (See “Editing sounds” steps ① - ② on p.20.)
- ② Start transmitting data from the transmitting device.



- After receiving completes, SAVE will appear on the display.

- ③ Press the **OK** button.



- After saving completes, DONE will appear on the display.

## Backing up user data

- ① While pressing the **TRACK 4** button, press the POWER switch to turn on the LIVEN XFM.
- ② Turn the **VALUE** knob to select EXPT.
- ③ Press the **OK** button to start transfer.





- The step button LEDs show the progress of data transmission. (They will light in order from step button LED 1. Transmission is complete when all step LEDs 1-16 have lit.)
- Regardless of data transmission status, the **CLR** button can be pressed to cancel.



# Saving and loading user data

---

button can be pressed to cancel.

- After transmission completes, DONE will appear on the display, and the unit will start up normally.
- The size of the backup data is 2,657,568 bytes.
- If the size of the data is different, the backup might have failed. If this occurs, before step ③, turn the  **VALUE** knob while pressing the  button to increase the transmission interval. (The default value is 0.)

## Restoring user data

- ① While pressing the  button, press the POWER switch to turn on the LIVEN XFM.
- ② Turn the  **VALUE** knob to select IMPT.
- ③ Press the  button, and start data transmission from the other device.



- The step button LEDs show the progress of data transmission. (They will light in order from step button LED 1. Transmission is complete when all step LEDs 1-16 have lit.)
- Regardless of the data reception status, the Crouton can be pressed to cancel. (Received data will be discarded.)

- ④ After receiving completes, SAVE will appear on the display. Press the  button to use the received data to restore the unit.





- After restoration completes, DONE will appear on the display, and the unit will start up normally.



# System settings

This section explains settings related to the system.



## Setting the automatic power off function

- ① Press and hold the  button.
- ② Press the  **SYSTEM** key, and select A.PWR.
- ③ Turn the  **VALUE** knob to select the automatic power off setting.



- Automatic power off has four settings.
  1. OFF: Automatic power off is disabled.
  2. 30 minutes (0.5 on display): Power will turn off automatically after 30 minutes without operation.
  3. 1 hour (1H on display): Power will turn off automatically after 1 hour without operation.
  4. 3 hours (3H on display): Power will turn off automatically after 3 hours without operation.
  5. 6 hours (6H on display): Power will turn off automatically after 6 hours without operation.
- Unsaved data will be cleared when the power turns off automatically. Always save data that is needed.



## Setting the battery type

- ① Press and hold the  button.
- ② Press the  **SYSTEM** key, and select BATT.
- ③ Turn the  **VALUE** knob to select the type of battery.



- Three types of batteries can be selected.
  1. Alkaline (ALKL on display)
  2. Nickel-metal hydride (NIMH on display)
  3. Lithium (LTHM on display)
- The remaining charge shown could be higher than the actual amount depending on the type of rechargeable battery.
- Please set this correctly because it effects operation time.



## Setting the master tuning

- ① Press and hold the  button.
- ② Press the  **SYSTEM** key, and select TUNE.
- ③ Turn the  **VALUE** knob to set the master tuning.



- The master tuning setting (in cents) will appear on the display.
- The setting range is -75 - +75.



## Setting the clock source

- ① Press and hold the  button.
- ② Press the  **CLOCK** key, and select SRC.
- ③ Turn the  **VALUE** knob to set the clock source.



- The clock source is shown on the display.
- Four types of clock sources can be selected.
  1. INTERNAL (INT on display): Use LIVEN XFM internal clock
  2. MIDI: Use clock from MIDI
  3. SYNC: Use clock from SYNC IN
  4. LINE IN (LN.IN on display): Use clock from LINE IN



## Setting SYNC IN polarity

- ① Press and hold the  button.
- ② Press the  **CLOCK** key, and select S.I.PO.
- ③ Turn the  **VALUE** knob to set the polarity.



- The polarity is shown on the display.
- Two types of polarity can be selected.
  1. FALL: Synchronizes with the falling of the sync signal.
  2. RISE: Synchronizes with the rising of the sync signal.

## Setting SYNC OUT polarity

- ① Press and hold the  button.
- ② Press the  **CLOCK** key, and select S.O.PO.
- ③ Turn the  **VALUE** knob to set the polarity.



- The polarity is shown on the display.
- Two types of polarity can be selected.
  1. FALL: Synchronizes with the falling of the sync signal.
  2. RISE: Synchronizes with the rising of the sync signal.

## Setting knob movement behavior

- ① Press and hold the  button.
- ② Press the latch button to turn knob latching on/off.



- Two types of knob movement behavior can be

# System settings



selected.

1. Jump (  button unlit): When a knob is moved, the parameter changes immediately.



2. Latch (  button lit red): The knob does not affect the parameter value until its position reaches that value. Then, the value follows the knob.

- When in latch mode, the movement of the dots on the display show the direction of the current parameter value. (If the parameter value is lower than the knob setting, they light to appear to be flowing left. If the value is higher, they appear to be flowing right. The farther away the value is, the faster they flow.)

## Enabling/disabling speaker output

- ① Press and hold the  button.
- ② Press the  key and select MUTE or SPK.

## Setting the headphone gain

- ① Press and hold the  button.
- ② Press the  GAIN key, and select the gain.



- The headphone gain is shown on the display.
- Three volume settings can be selected.
  1. LOUD
  2. NORM
  3. SOFT
- Set this correctly to prevent damage to the headphones or external device being used.

## Checking the system version



- ① While pressing the  button, press and hold the POWER switch.



- The LIVEN XFM will start up, and VER. will appear on the display.

- ② Press the  button to show the system version.



- The system version (S M.m) is shown on the display (M: major version, m: minor version).
- Press the  button to check the boot version (B M.m on display). Press the  button to check the

preset version (P M.m on display).

- Press the same page button again to show the build number.
- Press the  button to start up normally.

## Restoring to factory default settings (factory reset)

- ① While pressing the  button, press and hold the POWER switch.



- The LIVEN XFM will start up, and F.RST will appear on the display.

- ② Press the  button.



- After resetting completes, DONE will appear on the display.
- Press the  button to cancel.

## Updating the firmware



- ① While pressing the  button, press and hold the POWER switch.



- The LIVEN XFM will start up, and UPDT will appear on the display.

- ② Transmit the firmware from the sending device (Sys. Ex).



- The step LEDs will light to show the progress. (100% when step LED 16 is reached.)
- RCV will appear on the display.
- When receiving completes, the  button will light green and the  button will light red.

- ③ After transmission completes, press the  button to execute the update.



- Press the  button to cancel the update and start up normally.

# System settings

---

- The step LEDs will light to show the progress. (100% when step LED 16 is reached.)
- If the update occurred properly, DONE will appear. (If a problem occurred, an error code will appear.)

④ Restart the unit.

# Appendix

**Figure 1. Sound architecture**

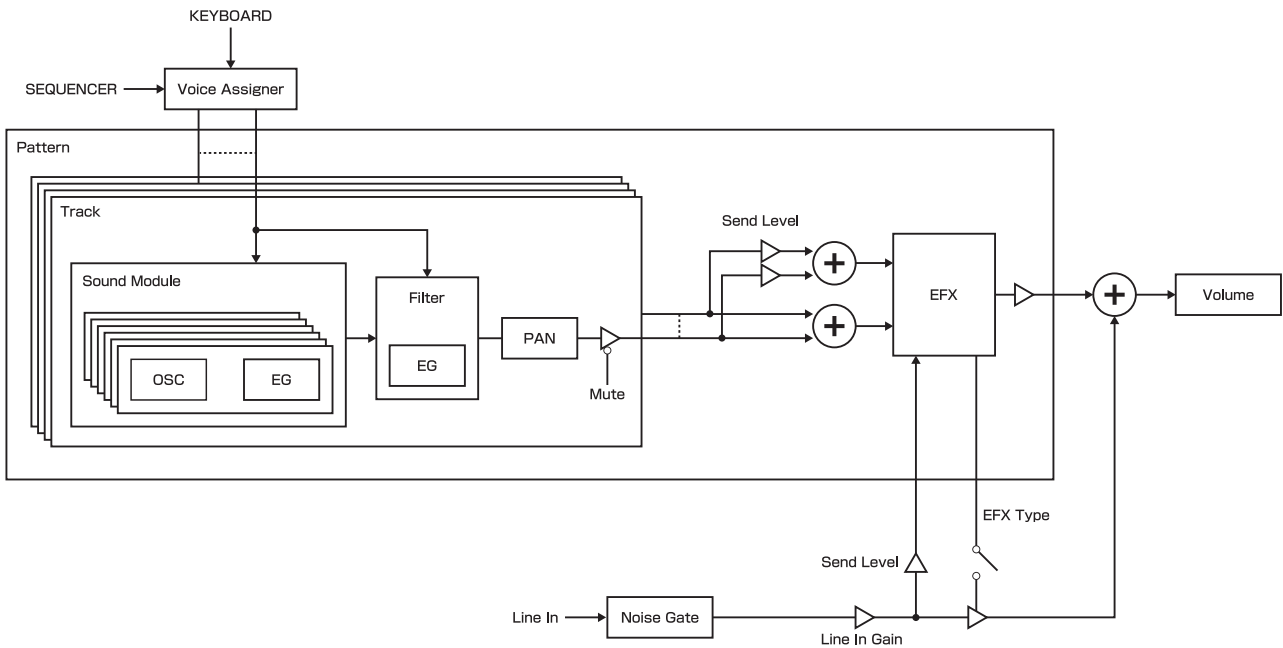

**Table 1. Synthesizer engine parameter list**

Synth engine	shift button	Main Knob 1	Main Knob 2	Main Knob 3	Main Knob 4
X-LAB	OFF	Sound 1	Sound 2	Combination	Combination color
		Sounds 1 to 16 of the selected bank (The default value is 1)	Sounds 1 to 16 of the selected bank (The default value is 2)	<63 ~ <01, 01> ~ 63> (The default value is <01>)	RED, ORNG, YLLW, GRN, BLUE, LI.BL, PRPL (The default value is RED)
	ON	Bank 1	Bank 2	Pitch lock & envelope lock	Tone
		1 ~ 32 (The default value is 1)	1 ~ 32 (The default value is 1)	---, --.EG, PT.--, PT.EG (The default value is PT.--)	0 ~ 127 (The default value is 127)
XFORM	OFF	Sound 1	Sound 2	Switching time	Delay
		Sounds 1 to 16 of the selected bank (The default value is 1)	Sounds 1 to 16 of the selected bank (The default value is 2)	0 ~ 127 (The default value is 10)	0 ~ 127 (The default value is 63)
	ON	Bank 1	Bank 2	Pitch lock & envelope lock	Switching color
		1 ~ 32 (The default value is 1)	1 ~ 32 (The default value is 2)	---, --.EG, PT.--, PT.EG (The default value is PT.--)	RED, ORNG, YLLW, GRN, BLUE, LI.BL, PRPL, WHT, BLCK (The default value is RED)

# Appendix

Synth engine	shift button	Main Knob 1	Main Knob 2	Main Knob 3	Main Knob 4
X-LFO	OFF	Sound 1	Sound 2	LFO rate	LFO shape
		Sounds 1 to 16 of the selected bank (The default value is 1)	Sounds 1 to 16 of the selected bank (The default value is 2)	0 ~ 127 (The default value is 63)	SINE (sine wave), SAQR (square wave), TRI (triangle wave), SAW (sawtooth wave), R.SAW (reverse sawtooth wave), RAND (random wave), LOG (logarithmic wave), R.LOG (reverse logarithmic wave) (The default value is SINE)
	ON	Bank 1	Bank 2	Pitch lock & envelope lock	Morphing color
		1 ~ 32 (The default value is 1)	1 ~ 32 (The default value is 1)	---, --.EG, PT.--, PT.EG (The default value is PT.--)	RED, ORNG, YLLW, GRRN, BLUE, LI.BL, PRPL, WHT, BLCK (The default value is RED)
LIBRARY	OFF	Bank	Sound	Attack time	Tone
		1 ~ 32 (The default value is 1)	1 ~ 16 (The default value is 1)	-63 ~ ORG ~ +63 (The default value is ORG)	0 ~ 127 (The default value is 127)
	ON	—	—	—	—
		—	—	—	—

## X-LAB

- 1 ↔ 2: This adjusts the balance of SOUND 1 and SOUND 2 in the combined sound.
- COLOR: This adjusts the balance of the operators in the combined sound.
- lock: This turns pitch and envelope locking on and off.
- tone: This adjusts high-frequency elements.

## XFORM

- TIME: This adjusts the time switching from SOUND 1 to SOUND 2
- DELAY: This adjusts the time before switching from SOUND 1 to SOUND 2.
- lock: This turns pitch and envelope locking on and off.
- color: This adjusts the balance of the operators at the time they change.

## X-LFO

- RATE: This adjusts the morphing frequency of SOUND 1 and SOUND 2.
- SHAPE: This adjusts the morphing shape.
- lock: This turns pitch and envelope locking on and off.
- color: This adjusts the balance of the operators at the time they change.

## LIBRARY

- ATTACK: This adjusts the attack time of each operator.
- TONE: This adjusts high-frequency elements.