

Lexicon® PCM96

Reverb/Effects Processor

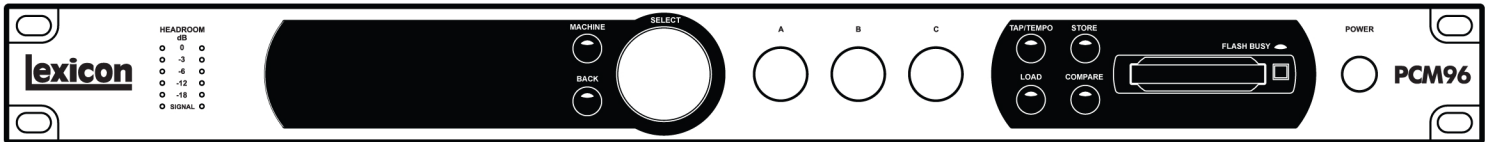

Lexicon®
by HARMAN

Professional Audio Equipment

WARRANTY

This warranty is valid only for the original purchaser and only in the United States. If outside the United States please contact the local Lexicon® distributor.

1. Please register your product online at lexiconpro.com. Proof-of-purchase is considered to be the responsibility of the consumer. A copy of the original purchase receipt must be provided for any warranty service.
2. Lexicon Professional warrants this product, when purchased new from an authorized U.S. Lexicon Professional dealer and used solely within the U.S., to be free from defects in materials and workmanship under normal use and service. This warranty is valid to the original purchaser only and is non-transferable.
3. Lexicon Professional's liability under this warranty is limited to repairing or, at our discretion, replacing defective materials that show evidence of defect, provided the product is returned to Lexicon Professional WITH RETURN AUTHORIZATION from the factory, where all parts and labor will be covered up to a period of 1 year. A Return Authorization Number must first be obtained from Lexicon Professional. The company shall not be liable for any consequential damage as a result of the product's use in any circuit or assembly.
4. Lexicon Professional reserves the right to make changes in design or make additions to or improvements upon this product without incurring any obligation to install the same additions or improvements on products previously manufactured.
5. The foregoing is in lieu of all other warranties, expressed or implied, and Lexicon Professional neither assumes nor authorizes any person to assume on its behalf any obligation or liability in connection with the sale of this product. In no event shall Lexicon Professional or its dealers be liable for special or consequential damages or from any delay in the performance of this warranty due to causes beyond their control.

TECHNICAL SUPPORT & SERVICE

If you require technical support, contact Lexicon Professional Technical Support. Be prepared to accurately describe the problem. Know the serial number of your device – this is printed on a sticker attached to the chassis.

Before you return a product to the factory for service, we recommend you refer to this manual. Make sure you have correctly followed installation steps and operating procedures. For further technical assistance or service, please contact our Technical Support Department at (801) 566-8800 or visit lexiconpro.com. If you need to return a product to the factory for service, you MUST first contact Technical Support to obtain a Return Authorization Number.

NO RETURNED PRODUCTS WILL BE ACCEPTED AT THE FACTORY WITHOUT A RETURN AUTHORIZATION NUMBER.

Please refer to the Warranty information, which extends to the first end-user. After expiration of the warranty, a reasonable charge will be made for parts, labor, and packing if you choose to use the factory service facility. In all cases, you are responsible for transportation charges to the factory. If the product is still under warranty, Lexicon Professional will pay the return shipping.

Use the original packing material if it is available. Mark the package with the name of the shipper and with these words in red: DELICATE INSTRUMENT, FRAGILE! Insure the package properly. Ship prepaid, not collect. Do not ship parcel post.

TABLE OF CONTENTS

INTRODUCTION	1
THE FRONT PANEL	2
THE REAR PANEL	4
USING THE PCM96	5
Powering Up the PCM96.....	5
The Preset Screen	5
Selecting Your Audio Source and Clock Source.....	6
Loading a Preset	6
Changing Categories	6
System Presets and Machine Presets	7
The Configuration Icon	8
Editing a Preset	9
Storing a Preset.....	10
Initializing/formatting a Compact Flash Card	11
Creating a new System Preset	11
DSP CONFIGURATIONS	12
Single Mono In Stereo Out	12
Single Stereo.....	12
Dual Mono	12
Cascade Stereo.....	12
Cascade Mono.....	12
Cascade Mono to Stereo.....	12
Combined Stereo Mono In	12
NETWORKING	13
Overview of TCP/IP Basics	13
Connecting the Computer Directly to the PCM96.....	14
Setup of a Simple Isolated Ethernet Network Using DHCP	14
Virtual Private Networks (VPN)	15
Network Considerations and Limitations.....	15
Network Troubleshooting.....	15
SYSTEM MENU	17
Audio Setup	17
Machine Config	18
MIDI Control.....	18
Tempo Control.....	19
Card Config.....	19
Network Config	19
HiQnet Config.....	19
Restore Factory Defaults.....	19
MACHINE MENU	20
Soft Row Setup	20
I/O Settings.....	20
Various Parameters	20
USING MIDI	20
Setup Definitions	21
Preset Loading.....	21
How to Assign a Base Channel to the PCM96.....	21
Channel Map (how channels map to machines).....	22
Bank Dump	22

Reverse Bank Dump (Bank “Load”).....	22
Continuous Controllers.....	22
Soft Row Parameter/MIDI CC Map.....	23
Bank/Preset Map.....	23
MIDI SysEx Implementation.....	24
THE ALGORITHMS.....	26
Chamber (Stereo and Mono).....	26
Random Delay (Stereo and Mono).....	26
Hall (Stereo and Mono).....	27
Random Hall (Stereo and Mono).....	28
Plate (Stereo and Mono).....	28
Dual Delay (Stereo and Mono).....	28
Resonant Chords (Stereo and Mono).....	29
Chorus/Flange (Stereo only).....	30
Concert Hall (Stereo only).....	30
Room (Stereo and Mono).....	30
Signal Generator.....	30
THE PARAMETERS.....	31
PCM96 MENU NAVIGATION MAPS.....	39
SPECIFICATIONS.....	48
MIDI IMPLEMENTATION CHART.....	51

INTRODUCTION

Congratulations and thank you for purchasing the PCM96 Reverb/Multi Effects Processor! The PCM96 offers legendary reverbs you've come to expect from Lexicon[®], plus new mono reverbs, new room algorithms with selectable, reversible reflection patterns, and more.

The PCM96's intuitive front panel makes operation simple. Just select a preset and load it to hear the reverb or effect you want. Adjust a preset's "soft row" parameters with the three Parameter knobs. Or dial up and adjust any parameter with the large Navigation knob. Save or load presets with a Compact Flash memory card. Use the Compare button to A-B the original preset with changes you've made to it.

With its unmatched reverbs and effects and intuitive interface, the PCM96 will prove to be a valuable addition in your studio.

THE FRONT PANEL

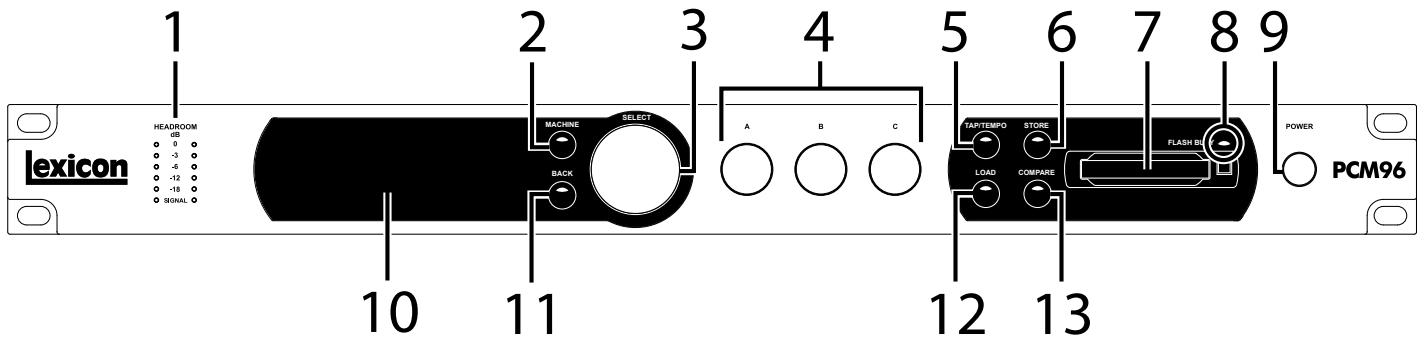

1. Gain LEDs

Each pair of Gain LEDs indicate input signal strength of each of the PCM96's inputs. If the Audio Source is set to Analog (in the Audio Setup menu), they show analog levels. If Audio Source is set to Digital, they show digital levels. Range is from -18dB, -12dB, -6dB, -3dB, and 0dB.

2. MACHINE Button

The PCM96 can be configured as a single system or as 1-4 "machines", each of which can run its own preset. The Machine button cycles the selected preset through its system and machine configurations.

3. SELECT Knob

Turn the Select knob to scroll through presets and menu options. Press the Select knob to select the current preset or menu option. Once you've selected a menu option, you can turn the Select knob to adjust the menu option's value (Press the Back button to accept the change.)

4. A, B, and C Knobs

These knobs adjust parameters shown in the Display. Turn Knob A to adjust the parameter in the top row, Knob B to adjust the parameter in the second row, and Knob C to adjust the parameter in the third row. Press Knob A to access additional pages of parameters when in the Soft Row. Press Knob C to view the current preset's Algorithm, Bank number, Program number, and MIDI channel. These knob also have additional context-sensitive functions when pressed.

5. TAP/TEMPO Button

Press two or more times to set tempo for delays and modulated effects. Look for presets with (T) in the name for effects that react to tempo.

6. STORE Button

Press to store a preset. When pressed, a menu appears in the Display where you can enter a new name for the preset.

7. Compact Flash Card Slot

Insert Compact Flash card here.

8. FLASH BUSY LED

This LED lights when the Compact Flash card is being read or written to. Do not remove the Compact Flash card when this LED is lit.

9. Power Button

Press to turn the PCM96 on or off.

10. Display

This high resolution, high contrast, and high viewing angle OLED (Organic LED) display shows menu and box configuration and status information.

11. BACK

Pressing this button moves you up one level in the menu tree. Note that when a System preset is loaded, this button takes you to the System Mode Category Selection menu. When a Machine preset is loaded, the Back button takes you to the Machine Mode Category Selection menu.

12. LOAD

Press this button to load the selected preset. You can also press the Select knob to load a preset.

13. COMPARE

This button is used to compare an edited preset against its unedited self. When a preset is loaded, this button's LED is off. As soon as the preset is edited in any fashion, the LED lights. If the button is pressed, the edited state is temporarily stored and the preset is reloaded from the file system. During this period of time, editing is disallowed and the button LED blinks rapidly. When the Compare button is pressed a second time, the edited state is restored, editing is allowed again, and the LED is illuminated.

THE REAR PANEL

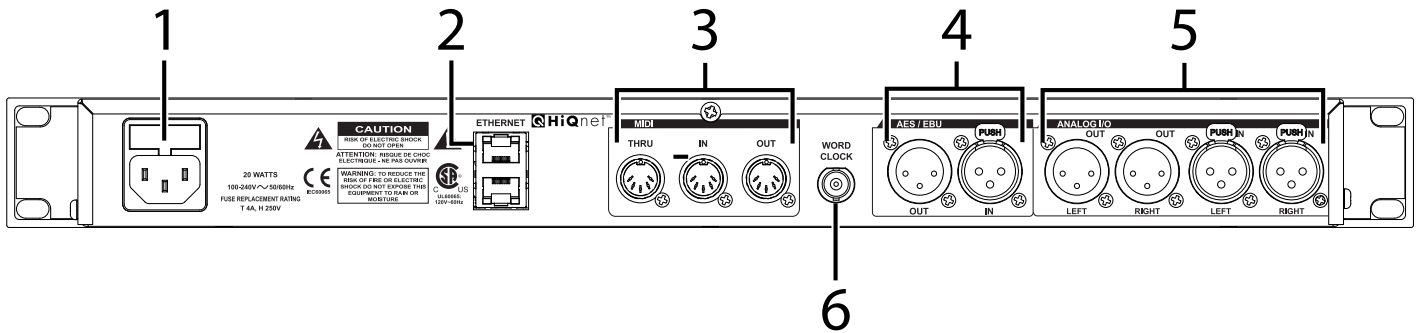

1. POWER JACK

Standard 3-pin IEC power connector. 100-240V, 50-60Hz automatic switching to correct voltage range.

2. ETHERNET INPUTS

These RJ-45 connections are used to network PCM96 devices and control them via Ethernet.

3. MIDI IN

Receives MIDI information from other MIDI equipment such as master keyboard controllers, MIDI foot controllers, sequencers and synthesizers.

MIDI THRU

Passes any MIDI data received without change.

MIDI OUT

Transmits MIDI data to other equipment.

4. AES/EBU In/Out

AES/EBU format digital connectors conform to AES professional standards.

5. ANALOG IN/OUT

Output impedance is 30 Ω , electronically balanced, and levels up to +20dBu maximum full scale.

6. WORD CLOCK INPUT

This connection allows the PCM96 to lock to a master system clock. It is not terminated. For best results we recommend using "T" connectors when setting up a BNC Word Clock network and terminating the end of of this network with a 75 ohm BNC terminator.

USING THE PCM96

POWERING UP THE PCM96

1. Plug in the power cord.
2. Press the Power button.
3. The Lexicon® logo appears, and remains until the boot process is complete. Next, the Preset screen appears, showing the currently loaded preset.

THE PRESET SCREEN

The Preset screen is the starting point for many of the instructions in this manual, so it's a good idea to know how to get to the Preset screen. In most cases, pressing the Back button one or more times will take you back to the Preset screen. If you press the Back button while viewing the Preset screen, you'll arrive at the Machine or System Category Selection screen. In this case, just turn the Select knob to select a category (the current category is marked with an asterisk), and press the Select knob to load it. You will then be taken to the Preset screen.

The Preset screen shows the current preset and configuration. Note that the Preset screen has two "views": *System view* (for System Presets) and *Machine view* (for Machine Presets). For more information, see "System Presets and Machine Presets" on page 7.

SYSTEM VIEW

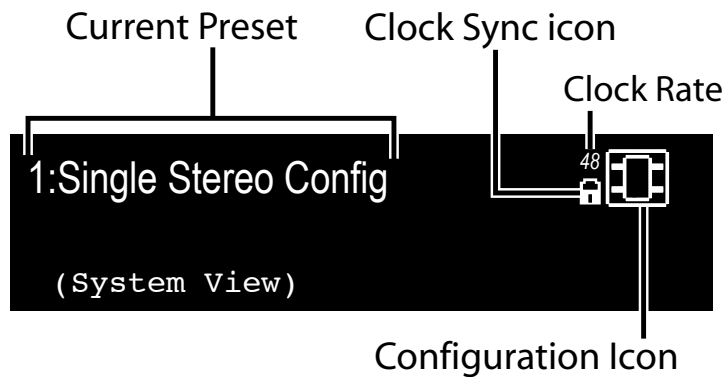

MACHINE VIEW

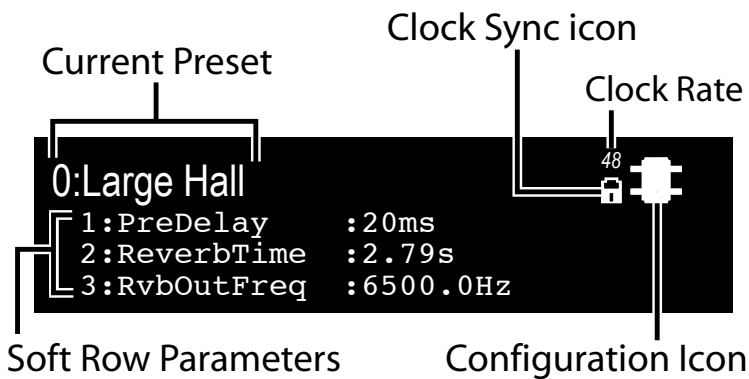

SELECTING YOUR AUDIO SOURCE AND CLOCK SOURCE

1. Press the Machine button until the words “System View” appear in the Display.

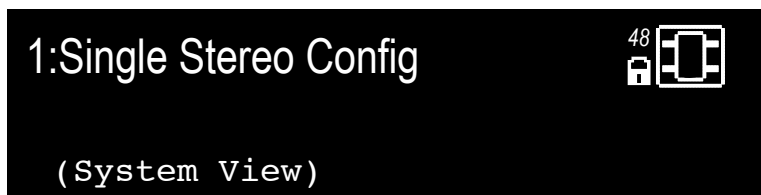

2. Press the Select knob. The System Menu appears.

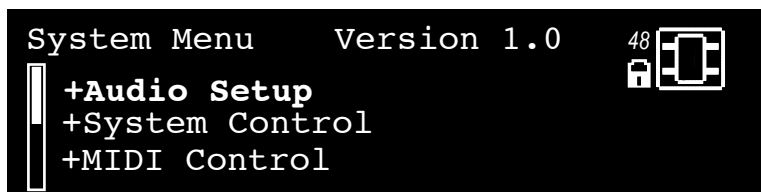

3. With Audio Setup highlighted, press the Select knob. The Audio Setup menu appears.

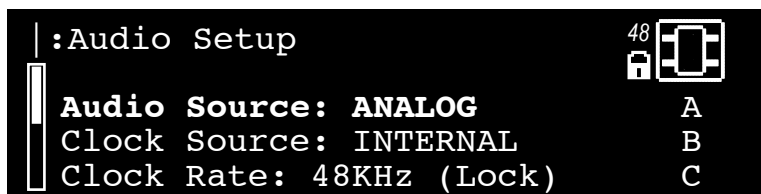

4. Turn Knob A to select your audio source (Analog or AES).
5. Turn Knob B to select your wordclock source (Internal, AES, or BNC).
6. Press the Back button twice to save your changes and return to the Preset screen.

LOADING A PRESET

1. From the Preset screen, turn the Select knob to scroll through the available presets in the current category. (Presets are arranged in categories within the PCM96; see **Changing Categories** below for more information.) The preset name blinks after you turn the Select knob, indicating that you are in preset selection mode.
2. Press the Select knob to load the preset you've selected. The display briefly reads Loading Preset, and the preset name appears. It is no longer blinking.

CHANGING CATEGORIES

Presets are grouped into categories in the PCM96. Each category has its own set of presets. When you turn the Select knob while viewing a preset, you only see presets available in the current category.

System Presets and Machine Presets each have their own set of categories. System Preset categories are based on DSP configurations (see “DSP Configurations” on page 12), and Machine Preset categories are based on

algorithms (see “The Algorithms” on page 26).

System Presets and Machine Presets also have User and Card categories, where you can access user-edited presets. Presets in the User category are stored on the PCM96, and presets in the Card category are stored on a Compact Flash card.

To select a different category

1. From the Preset screen, press the Back button. The Category Selection screen appears. Note that there are different Category Selection screens for System Presets and Machine Presets:

Category Selection Screen - System Presets

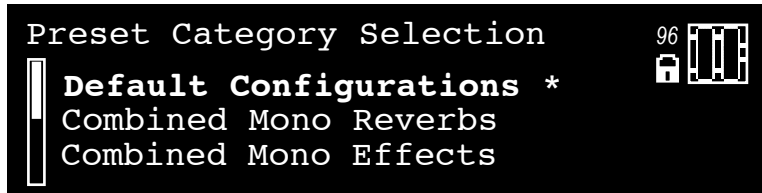

Category Selection Screen - Machine Presets

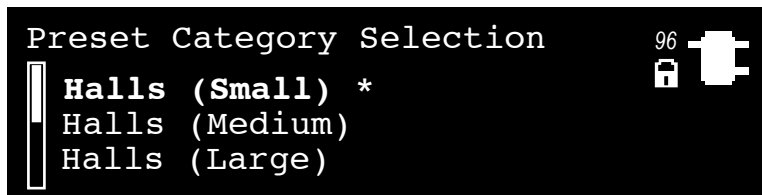

2. Turn the Select knob to scroll through the available categories. (An asterisk appears next to the currently selected category.)
3. Press the Select knob to load the highlighted category. A flashing preset name appears (if it is not the currently selected preset).
4. Select a preset with the Select knob, and press the Select knob to load it.

SYSTEM PRESETS AND MACHINE PRESETS

The PCM96 features a single powerful processor, which can be used as up to four *virtual machines*. For example, you could send the left input signal through a mono reverb in one virtual machine and send the right input signal through a mono delay in another virtual machine. You could then send both signals through a chorus effect on a third virtual machine. You could then save this configuration as a **System Preset**. It's a preset that includes a system of virtual machines.

System Presets can be extremely complex and are generally tailored especially for the mix you're working on. Lexicon® has provided a number of these presets, just to give you an idea about what you might do. Who knows? You might like them just the way they are. Feel free to make modified versions of the factory presets, or create your own from scratch. The possibilities are nearly endless, so have fun.

When a preset only includes a single virtual machine, it's called a **Machine Preset**.

Note that pressing the Back button or the Select knob have different results depending on what kind of preset is loaded. The following diagram shows what happens when you press the Select knob, Back button, and Machine button in both System View and Machine View.

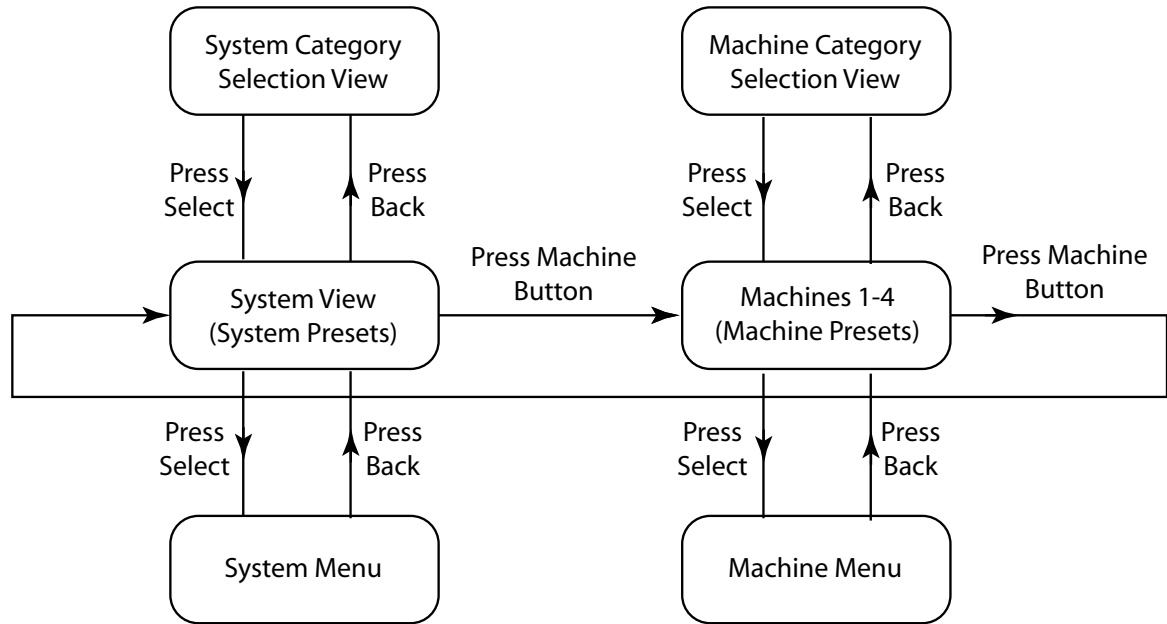

THE CONFIGURATION ICON

The *Configuration icon* appears at the upper right corner of the Display. It tells you if a System Preset or a Machine Preset is loaded.

When a System Preset is loaded, a border appears around the Configuration icon and the words **System View** appear in the Display, below the preset's name.



Configuration Icon
(System Preset)

When a Machine Preset is loaded, the selected machine is highlighted in the Configuration icon, and three of the loaded preset's parameters appear at the bottom of the Display.

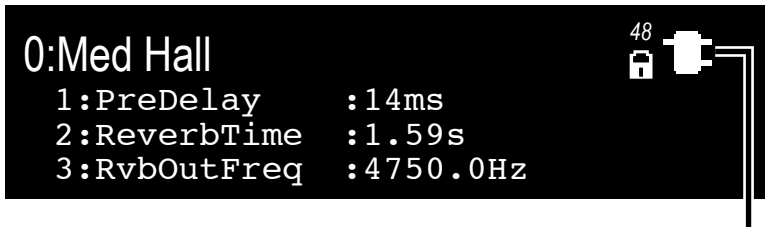

Configuration Icon
(Machine Preset)

Press the Machine button repeatedly to cycle through the virtual machines in a System Preset, and eventually back to the System Preset.

EDITING A PRESET

To edit a System Preset, you must edit the virtual machines within it. Press the Machine button to cycle through the virtual machines within a System Preset.

Each virtual machine contains a set of parameters that you can edit and adjust. When a virtual machine is selected, three of its parameters appear at the bottom of the Display. Adjust the first parameter with Knob A, the second parameter with Knob B, and the third parameter with Knob C. To see the next set of parameters you can adjust, **press** Knob A.

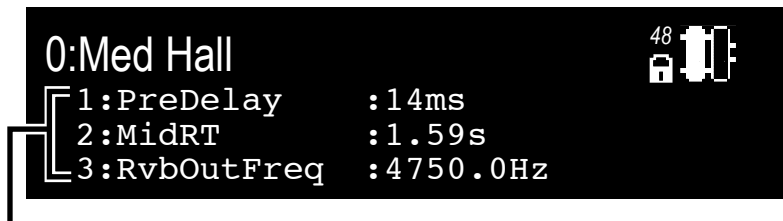

Soft Row Parameters

Each virtual machine has 8 parameters you can adjust this way. All presets have more than 8 parameters, but only 8 can be edited via the A, B, and C knobs in this fashion. You can choose which parameters are in the list by using the Soft Row Setup menu located in the Machine menu (see “Machine Menu” on page 20).

STORING A PRESET

Once you've edited a preset, you can store it on the PCM96 (in the User category) or on a Compact Flash card (in the Card category).

Note: When you first insert a Compact Flash card, you may receive the message "Card Needs Initializing." See "Initializing/formatting a Compact Flash Card" on page 11 for instructions on how to initialize a Compact Flash card.

1. From the Preset screen, press the Store button. The Save As screen appears.

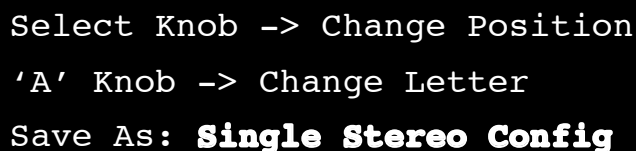

```
Select Knob -> Change Position
'A' Knob -> Change Letter
Save As: Single Stereo Config
```

2. Turn the Select knob to select a letter to change.
3. Turn Knob A to change the selected letter.
Press Knob A to toggle between uppercase, lowercase, special characters and numbers.
Press Knob B to clear the selected character space.
4. Repeat steps 2 and 3 until you've changed all the letters you want to change.
5. Press the Select knob to continue. If a Flash card is inserted, the Location menu appears. (If no Flash card is inserted, skip to step 8.)



```
█ User
  Card
```

6. Turn the Select knob to select a location. "User" is the PCM96 built-in memory; "Flash" is the inserted Compact Flash card (if one is present).
7. Press the Select knob to continue. The numbered list appears.



```
█ 0:- Empty -
  1:- Empty -
  2:- Empty -
  3:- Empty -
  4:- Empty -
```

8. Turn the Select knob to select a slot in the numbered list. The preset's name automatically appears in the selected slot.
9. Press the Select knob to save the preset to the selected slot. "Storing Preset" appears briefly in the Display and you are returned to the Preset screen.

INITIALIZING/FORMATTING A COMPACT FLASH CARD

To initialize or format a Compact Flash card:

1. Press the Back button until the Preset screen appears.
2. Press the Machine button until System View is displayed.
3. Press the Select knob to enter the System Menu.
4. Turn the Select knob until Card Config is highlighted.
5. Press the Select knob to access the Compact Flash Menu.
6. Press Knob B to Format the card OR press Knob C to initialize the card.

CREATING A NEW SYSTEM PRESET

One way to create a new System Preset is to edit an existing System Preset and save it to the User or Card category. Another way is to start from scratch, as described below.

1. With any System Preset loaded, press the Select knob. The System menu appears.
2. Highlight Machine Config with the Select knob, and press the Select knob. The available DSP configurations appear.
3. Turn the Select knob to highlight a configuration and press the Select knob to choose it. You return to the Preset Screen. The preset's name indicates the configuration you just selected (for example, if you selected the Cascade Stereo configuration, the preset's name is Cascade Stereo Config).
4. Press the Machine button to select a Machine Preset within your System Preset.
5. Press the Back button to access the Preset Category menu.
6. Turn the Select knob to highlight a category and press the Select knob to choose it. A flashing Machine Preset name appears.
7. Turn the Select knob to choose a Machine Preset and press the Select knob to load it.
8. Press the Machine Button to choose the next Machine Preset (if there is one) and repeat steps 5 through 7.
9. Repeat step 8 for each virtual machine in your System Preset.
10. Press the Machine Button until your System Preset is selected.
11. Store the System Preset. For more information on storing presets, see "Storing a Preset" on page 10.

DSP CONFIGURATIONS

The PCM96 processor can be divided in up to four virtual machines, each of which can run its own algorithm. This lets you route signals from each input through a variety of algorithm combinations.

The PCM96 can use up to two physical inputs and two physical outputs at a time; configurations for the physical inputs and outputs are described below.

SINGLE MONO IN STEREO OUT

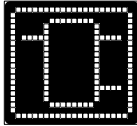

A mono signal is split into a stereo signal.

SINGLE STEREO

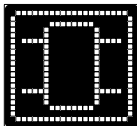

The left and right inputs are sent through a single virtual machine.

DUAL MONO

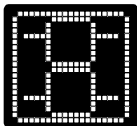

The left signal travels through one virtual machine, and the right signal travels through a separate second virtual machine.

CASCADE STEREO

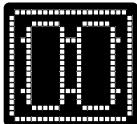

The left and right signals are processed together in one virtual machine, and the resulting signal is sent to a second virtual machine, where they are again processed together.

CASCADE MONO

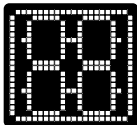

The left signal is sent through two virtual machines in sequence, while the right signal is sent through two additional virtual machines in sequence. The left and right signals are processed independent from each other.

CASCADE MONO TO STEREO

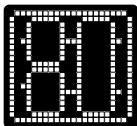

The left and right signals are processed independently in two separate virtual machines, and their resulting signals are processed together in a third virtual machine. The final result is output as stereo.

COMBINED STEREO MONO IN

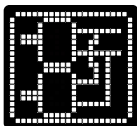

This configuration features two stereo machines. Each receives one of the input channels. The two stereo outputs are combined and output as a single stereo pair.

NETWORKING

This section provides a step-by-step guide on how to properly connect the PCM96 to a Local Area Network (LAN) for several different network architectures. The first topology is a simple direct connection using the provided Ethernet cable. The second method describes how to connect and configure several PCM96 units to create an isolated network using an Ethernet switch with static IP addresses or with DHCP. This section concludes with some further networking considerations and troubleshooting tips that will help with connecting to your PCM96 via Ethernet. If your application is more than these simple examples we recommend that you involve a trained Ethernet network administrator in the design and commissioning of your system.

Careful planning needs be made before placing a PCM96 on a network that provides any access to the public. Some examples of public access are direct access to the unit from the Internet, an unsecured or weakly secured wireless network, a network jack in a public area that provides network access to the PCM96, or having a computer on the LAN that is not secured so that someone could use it to reconfigure the PCM96. It is highly recommended that the equipment be placed on a protected, isolated network that does not have any connection to the public to prevent unauthorized users from reconfiguring the unit. Please refer to the VPN portion of this section for more information. Factory defaults for the Internet Protocol (IP) settings for the PCM96 are as follows:

Auto-IP/DHCP Address:	169.254.x.x (where “x.x” is determined by the PCM96 box numbers)
Subnet Mask:	255.255.0.0
Gateway:	0.0.0.0
DHCP Support:	Enabled

OVERVIEW OF TCP/IP BASICS

IP ADDRESS

An identifier for a computer or device on a TCP/IP network. Each device in a network has its own IP address to identify it. Example: 126.126.17.42. Networks using the TCP/IP protocol route messages based on the IP address of the destination. An IP address is made of four numbers separated by periods. Each number can be zero to 255. The last number should not be a zero or 255. For example, 126.126.17.1 could be an IP address. 126.126.17.0 would not be a valid IP address. A TCP/ IP or IP address has two parts: the NETWORK ID and the HOST ID. The NETWORK ID identifies the network, and the HOST ID identifies either the subnet and device, or just the device if there is no subnet. The subnet mask is a code that indicates which part of the TCP/IP address is the NETWORK ID and which part is the HOST ID. In subnet-mask code, 255 means “This part of the address is the NETWORK ID”. Example: Suppose the IP ADDRESS of a device is 192.168.xx.yy and the SUBNET MASK is 255.255.x.y. That means, (192.168) is the NETWORK ID. The remaining set of numbers (xx.yy) is the HOST ID. If your network stands alone (it is not part of a larger network) then the HOST ID identifies each device in the network. If your network is part of a venue’s larger network, your network is actually a sub-network or subnet.

SUBNET

A small network within a larger network. For example, a TCP/IP network might be a subnet of a venue's network, which could include computers throughout the building, or a network might be divided into subnets. For example, in a large installation, there may be one subnet per rack or room.

DHCP (DYNAMIC HOST CONFIGURATION PROTOCOL)

This is a protocol for automatically assigning IP addresses to devices on a network. With dynamic (DHCP) addressing, a device might have a different IP address every time it connects to the network. DHCP relies on a DHCP server to assign and manage IP addresses.

AUTO IP

If DHCP fails, the PCM96 selects a number and looks for collisions. If no collisions are found, the PCM96 accepts that number. If collisions are found, the PCM96 randomly selects another number and tries again.

CONNECTING THE COMPUTER DIRECTLY TO THE PCM96

Assumptions:

- Computer has a working Ethernet network adapter.
 - You have administrative rights so that network settings can be changed if necessary.
1. Connect the included Ethernet cable to both the PCM96 and the computer.
 2. Apply power to the PCM96 and wait for it to boot.
 3. Open the control software application. The PCM96 should automatically appear in the main application window. If it does not, the control software settings may have to be configured to connect to the PCM96. See the control software's help for more information.

SETUP OF A SIMPLE ISOLATED ETHERNET NETWORK USING DHCP

Assumptions:

- Computer has a working Ethernet network adapter.
 - You have an Ethernet switch/router with DHCP capability and Ethernet cables for each connection needed.
 - You have administrative rights so that network settings can be changed if needed.
1. Connect the computer and any PCM96 processors to the switch hub using straight-through Ethernet cables.
 2. Apply power to all PCM96 processors and wait for them to boot.
 3. With DHCP enabled, the Ethernet switch/router should assign an IP address to each of the devices including your computer.
 4. Open the control software application. The PCM96 should automatically appear in the main application window. If it does not, the control software settings may have to be configured to connect to the PCM96. See the control software's help for more information.

VIRTUAL PRIVATE NETWORKS (VPN)

Virtual private networks (VPN) provide an encrypted connection (or tunnel) between networks or between a network and a user over a public network (such as the Internet). Instead of using a dedicated, real-world connection such as a leased line, a VPN uses virtual connections through the public network. The advantage to a VPN is that your computer can be virtually connected to a local network even though it is physically anywhere in the world where you have an internet connection. This can also be done in a safe manner not compromising your local network's security. If you would like to manage your PCM96 units remotely you should create a secure VPN connection.

There are many solutions on the market today that provide VPN access. These products offer different features, methods of VPN, complexity of setup and maintenance, as well as varying levels of security. It is beyond the scope of this manual to recommend a VPN solution that will best suit the needs of your network, although you will need a VPN that is capable of passing UDP and TCP traffic (most do). The PCM96 has been tested against several solutions and should work with all VPNs that meet these criteria. Please work with your system administrator and Internet service provider to find a VPN that will best fit your network. The 3Com OfficeConnect Secure Router (model # 3CR860-95) is one solution that has been tested, and is both inexpensive and simple to set up. It provides up to two concurrent VPN connections.

NETWORK CONSIDERATIONS AND LIMITATIONS

- Without a VPN, there can be no access from the outside world to any PCM96 that is behind a Network Address Translation (NAT) router. (One-to-One NAT and port forwarding will not work.)
- Firewall Considerations: The PCM96 uses port 3804 (udp and tcp) to communicate with the control software. Make sure that you configure your firewalls correctly so that data sent to and from this port number can traverse your network.

NETWORK TROUBLESHOOTING

If you are having difficulty getting your PCM96 to show up in the control software, here are some things that you can try to resolve the problem.

SOFTWARE FIREWALL

If the PC that you have installed the control software on has a built-in firewall you need to make sure that you allow the software the ability to talk on your network. Try disabling your firewall and then going offline and back online in the control software. If this fixes the problem, refer to your firewall manufacturer's documentation on how to reconfigure your firewall to allow the control software and/or port 3804 tcp and udp to pass through the firewall.

ETHERNET LINK

Make sure that you have a valid Ethernet connection by looking at the link status lights. Most Ethernet devices will have some kind of indicator that shows the link is present. Check the following connections:

- PCM96 device – If there is a valid connection on the PCM96 you will see a solid green LED.
- PC running the control software

- Hub / Switch (if used)

If you fail to see a link light try removing and reinserting the cable or trying a different, known good, cable. Also, make sure that you are using the correct cable.

PING

There is a simple utility built into OS X that tests the network connection between two devices. The following steps outline how to use this utility.

1. In the Applications folder, double click the Terminal icon.
2. At the prompt enter ping -c 4 <IP address of your PCM96> and press Enter. The data should appear something like this:

```
PING <IP address of your PCM96>: 56 data bytes
64 bytes from <IP address of your PCM96>: icmp_seq=0 ttl=62 time=1.118 ms
64 bytes from <IP address of your PCM96>: icmp_seq=1 ttl=62 time=1.093 ms
64 bytes from <IP address of your PCM96>: icmp_seq=2 ttl=62 time=1.067ms
64 bytes from <IP address of your PCM96>: icmp_seq=3 ttl=62 time=1.042ms
```

```
--- <IP address of your PCM96> ping statistics ---
4 packets transmitted, 4 packets received, 0% packet loss
round-trip min/avg/max = 1.042/1.08/1.118 ms
```

If you get a “Reply from” response from the IP address that you were ping- ing in a timely manner, it means that you have a valid network connection between the two devices.

If you receive a “No route to host” or “0 packets received” message, this indi- cates that your computer is not communicating with the device.

SYSTEM MENU

The System Menu lets you adjust several settings in the PCM96. To access the System Menu, press the Select knob while a System Preset is loaded.

The System Menu contains *sub-menus* and *options*. Sub-menus contain options and/or more sub-menus. To enter a sub-menu, highlight it with the Select knob and press the Select knob. Options contain values that you can adjust (indicated by a colon followed by a value, for example, “Audio Source: ANALOG”). To adjust an option’s value, turn the corresponding knob: Knob A for an option on the first line, Knob B for an option on the second line, and Knob C for an option on the third line. Press the Back button at any time to save your changes and move one level up through the menus and sub-menus.

AUDIO SETUP

The Audio Setup sub-menu contains the following options:

Audio Source

This is a global setting that configures the PCM96 to accept ANALOG or AES input.

Clock Source

Select your clock source here. Choose from INTERNAL, AES, and BNC.

Clock Rate

Select your clock rate here, when the wordclock source is set to INTERNAL. Choose from 44.1KHz, 48KHz, 88.2KHz, or 96KHz.

Analog Setup

The Analog Setup sub-menu lets you adjust the following parameters:

Analog Input Level - Increases or decreases the incoming analog signal before it reaches the processor(s). Set to +4dBu or -10dBu.

Analog Output Level - Increases or decreases the outgoing analog signal after it leaves the processor(s). Set to +4dBu or -10dBu.

Analog Type IV™ - Enable or disable the Type IV conversion system here. The dbx® Type IV Conversion System is a proprietary analog-to-digital (A/D) conversion process that combines the best attributes of digital conversion and analog recording processes to preserve the essence of the analog signal when it is converted to a digital format.

Global Mute - Mutes all signals from the PCM96. Set to Muted or Unmuted.

AES Setup

The AES Setup sub-menu gives you the status of the following AES information:

Data Validity - “Valid” indicates the data is OK. “Invalid” indicates that the Validity bit was set in a frame of incoming data and that the data attached to it may be corrupted. This bit may also be sent when the

transmitting device is paused.

Mode - This parameter can not be edited. The PCM96 always transmits professional AES signal out of the AES connector.

Confidence Error - “0” indicates no problem. “1” indicates the PCM96 is detecting excessive jitter or noise on the digital audio line. No data has been corrupted, but corrective action should be taken.

Sample Slip - An unchanging number indicates you are not slipping samples. An increasing number indicates samples are misaligned with the window defined by the Input Source. This may occur when an external master changes sample rate, or when it is just powering up, but should not occur in normal operation.

Bi-Phase Error - “0” indicates no problem. “1” indicates that at least one bit (and therefore at least one audio sample) was corrupted.

CRC Error - “0” indicates no problem. “1” indicates a Cyclic Redundancy Check error in the incoming data.

Parity Error - “0” indicates no problem. “1” indicates that at least one bit (and therefore at least one audio sample) was corrupted.

MACHINE CONFIG

The Machine Config menu lets you configure the PCM96 processor as one, two, three, or four virtual machines in a new preset. Note that once you’ve selected a configuration, you must then populate each virtual machine with a Machine Preset (see “Editing a Preset” on page 9).

Choices include:

Single Mono In Stereo Out

Single Stereo

Dual Mono

Cascade Stereo

Cascade Mono

Cascade Mono to Stereo

Combined Stereo Mono In

See “DSP Configurations” on page 12 for more detailed descriptions of each configuration,

MIDI CONTROL

The MIDI Control sub-menu lets you adjust the following MIDI-related options:

MIDI

Turns MIDI processing on or off.

Device ID

Select the connected MIDI device’s ID here. Choose from 0-126.

Base Channel

Select the connected MIDI device's base channel here. Choose from 0-15.

Bank Dump

Lets you copy an entire bank of presets from the PCM96 to another device via MIDI. (see "Bank/Preset Map" on page 23 for a map of banks and presets; to see the current preset's bank number, press Knob C while viewing the Preset screen.) When Bank Dump is highlighted, turn the corresponding B or C Knob to select a bank. Press the corresponding B or C Knob to send the bank to the connected device.

TEMPO CONTROL

The Tempo Control sub-menu contains the following options:

Tempo Value

Set the current preset's tempo here by turning Knob A, or by pressing the Tap Tempo button at least two times.

Tempo Beat

Tempo is expressed in BPM. This control allows you to specify the value of the beat. Eighth, quarter, and half note values are available. If, for example, the rate is 120 BPM, and you select eighth-note here, the tempo will be 120 eighth-notes per minute. If you select quarter-note here, the tempo will be 120 quarter-notes per minute. (The factory default is quarter-note.)

Tempo Source

Select INTERNAL to determine the tempo using parameters within the PCM96, or MIDI to set the tempo using MIDI beat clock. Refer to your DAW's manual to learn how to transmit this value.

CARD CONFIG

The Compact Flash Setup sub-menu indicates whether a Compact Flash card is INSERTED or NOT INSERTED, and gives you the options to Format (erase) the inserted card by pressing Knob B, or initializing the inserted card by pressing Knob C.

NETWORK CONFIG

Here you can set the PCM96 Subnet Mask, IP Address, Gateway, and DHCP information. Turn the Select knob to select a three-digit number (of the DHCP value) and turn Knob A to change the number (or the DHCP value). See "Networking" on page 13 for more details.

HIQNET CONFIG

Set the HiQnet Negotiation Mode (Static, Random, or Sequential) and Node Address here. Turn the Select knob to underscore a value and turn Knob A to change the value.

RESTORE FACTORY DEFAULTS

Returns the PCM96 to its original state as shipped from the factory.

MACHINE MENU

The Machine menu lets you adjust settings for a single virtual machine. To access the Machine menu, press the Select knob while a Machine Preset is loaded.

The sub-menus vary depending on what algorithm is active.

SOFT ROW SETUP

This sub-menu lets you assign parameters to a Machine Preset's soft row. The soft row is the list of parameters that appears below a Machine Preset's name in the Preset screen. You can easily adjust these parameters with the A, B, and C knobs (press Knob A to see more parameters in the soft row).

I/O SETTINGS

Here you can adjust the following settings (depending on the selected preset):

Wet Dry Mix

Adjusts the proportion of wet (processed) signal to dry (unprocessed) signal. Ranges from 0% (all dry) to 100% (all wet). In almost all cases you will leave this at 100%, and control levels on your mixer.

Input Level

Controls the amount of signal admitted into the process from the input. Ranges from 0.0dB INV to -90.0dB INV or OFF INV, and from -90.0dB or OFF to 0.0dB.

Output Level

Controls the amount of post-mix signal emitted onto the output. Ranges from -90.0dB or OFF to 0.0dB.

VARIOUS PARAMETERS

The sub-menus that appear below the I/O Settings sub-menu depend on the active algorithm. See "The Parameters" on page 31 for more information.

USING MIDI

The MIDI Control menu is where all MIDI related control is changed. See "MIDI Control" on page 18 for information about the MIDI Control menu.

MIDI in the PCM Device series can be setup in two basic configurations.

Setup #1 – More Devices

This setup is designed for the user who will:

- Use the PCM System Presets (User or Default) only for either a live or studio setup
- Control more than 3 PCM Devices on the same MIDI Port

Setup #2 – More Control

This setup is designed for the user who:

- Wants to be able to control every aspect of MIDI on the PCM Device

- Only has 1 to 3 PCM Devices

SETUP DEFINITIONS

Setup #1 – More Devices: This setup would be used in situations where you want to control more than 3 PCM Devices on the same MIDI port. This setup will control up to 16 PCM Devices. In this particular setup configuration, you cannot make specific patch changes on individual machines via MIDI; you can only change the System Presets.

You would arrange the MIDI Control Menu in this way:

MIDI: ON

Sysex Device ID: 0

System MIDI Ch: 0

(Each subsequent PCM Device would be the next number... 0 – 15.)

Machine 1 MIDI Ch: OFF

Machine 2 MIDI Ch: OFF

Machine 3 MIDI Ch: OFF

Machine 4 MIDI Ch: OFF

Setup #2 – More Control: This setup allows the user to control all the aspects of the PCM Device that can be controlled via MIDI. However, the user is limited to a maximum of 3 PCM Devices with this setup. The user can define the Machine Configuration on one MIDI channel, then define what preset will be loaded in each Machine using different MIDI channels. This setup also allows each Soft Row parameter on each Machine to be controlled with MIDI Continuous Controllers.

You would arrange the MIDI Control Menu in this way:

MIDI: ON

Sysex Device ID: 0

System MIDI Ch: 0

(Each subsequent PCM Device would then start on MIDI channel 5, with each machine as Channel +1.)

Machine 1 MIDI Ch: 1

Machine 2 MIDI Ch: 2

Machine 3 MIDI Ch: 3

Machine 4 MIDI Ch: 4

PRESET LOADING

Because of the large number of potential presets in the PCM96, Preset Change messages are used along with the Bank Select extension to provide MIDI preset selection. Controller 32 is used to select the current preset bank. Controller 32 is sent to the system (to select the desired bank), followed by a Preset Change message to select a preset. The Bank values are “sticky,” meaning the PCM96 will remember the Bank values for each MIDI channel. It is not necessary to send a Bank change with each Preset Change unless the Bank has indeed changed.

HOW TO ASSIGN A BASE CHANNEL TO THE PCM96

The base channel identifies a PCM96 unit to a MIDI device. Add 1, 2, 3, or 4 to the unit’s base channel to identify virtual machines within the unit. You can connect up to three PCM96 units to a single MIDI device.

To assign a base channel to the PCM96:

1. Press the Back button until the Preset screen appears.
2. Press the Machine button until System View is displayed.
3. Press the Select knob to enter the System Menu.
4. Turn the Select knob until Midi Control is highlighted.
5. Press the Select knob to access the Midi Control Menu.
6. Turn the Select knob until Base Channel is highlighted.
7. Turn Knob B to select the base channel (0-15).
8. Press the Back button twice to return to the Preset screen.

Now the PCM96 unit is identified by the selected base channel, and virtual machines 1, 2, 3, and 4 within the PCM96 are identified by the base channel plus 1, 2, 3, and 4, respectively.

CHANNEL MAP (HOW CHANNELS MAP TO MACHINES)

Channel	Usage	Description
Base Channel	System Level	Use for loading System presets. This is the PCM96 unit's base channel. The next four channels apply to this PCM96 unit's virtual machines.
Base + 1	Virtual machine 1	Changes parameters in one virtual machine in a System preset on the PCM96 unit with base channel 0. Use for loading machine presets and changing parameters for machine #1.
Base + 2	Virtual machine 2	Changes parameters in one virtual machine in a System preset on the PCM96 unit with base channel 0. Use for loading machine presets and changing parameters for machine #2.
Base + 3	Virtual machine 3	Changes parameters in one virtual machine in a System preset on the PCM96 unit with base channel 0. Use for loading machine presets and changing parameters for machine #3.
Base + 4	Virtual machine 4	Changes parameters in one virtual machine in a System preset on the PCM96 unit with base channel 0. Use for loading machine presets and changing parameters for machine #4.

BANK DUMP

The Bank Dump feature lets you copy all the presets in a User bank from one PCM96 to another (or to another MIDI device). See "MIDI Control" on page 18 for information about Bank Dump.

REVERSE BANK DUMP (BANK "LOAD")

You can perform a "reverse bank dump" by recording a bank dump to your MIDI sequencer, then playing that sysex back to the PCM96 to restore the bank.

CONTINUOUS CONTROLLERS

All PCM96 soft row parameters can be controlled with single, 7-bit controllers. Each parameter is controlled with the full controller range, regardless of the parameter range. For example, if the controller is at the midpoint of its range (64), the parameter will also be at the midpoint of its range no matter what the actual number.

Continuous Controllers range from 0 to 127. If the parameter range is less than 127, then a small controller change might not result in a parameter update. But the entire range of the parameter can still be accurately controlled. In addition, if the actual range of the parameter is greater than 127, MIDI control might be somewhat coarse. This is most noticeable with large delays.

When MIDI is enabled, the PCM96 automatically sends MIDI messages through the MIDI Out port for soft row parameters and preset loads whenever those actions are performed via the front panel controls.

SOFT ROW PARAMETER/MIDI CC MAP

Soft Row Parameter	MIDI CC
Parameter #1	CC 48
Parameter #2	CC 49
Parameter #3	CC 50
Parameter #4	CC 51
Parameter #5	CC 52
Parameter #6	CC 53
Parameter #7	CC 54
Parameter #8	CC 55

BANK/PRESET MAP

User Bank	Type		Presets	MIDI Bank #
Internal	Mono	1	Mono User Presets 0-127	72
		2	Mono User Presets 128-255	73
	Stereo	1	Stereo User Presets 0-127	74
		2	Stereo User Presets 128-255	75
	System	1	System User Presets 0-127	76
		2	System User Presets 128-255	77
Flash Card (PCM96 and PCM96 Surround Only)	Mono	1	Mono User Presets 0-127	100
		2	Mono User Presets 128-255	101
		3	Mono User Presets 256-383	102
		4	Mono User Presets 384-511	103
	Stereo	1	Stereo User Presets 0-127	104
		2	Stereo User Presets 128-255	105
		3	Stereo User Presets 256-383	106
		4	Stereo User Presets 384-511	107
	System	1	System User Presets 0-127	108
		2	System User Presets 128-255	109
		3	System User Presets 256-383	110
		4	System User Presets 384-511	111

MIDI SYSEX IMPLEMENTATION

COMMAND 0: REQUEST PRESET DUMP

When this command is received by the PCM96, it will respond with a preset dump of the requested preset. If the preset does not exist, the PCM96 will not respond. Only presets from User banks may be requested. Factory banks will not be transmitted.

Byte	Definition	Comments
0xF0	Sysex message	
0x06	Lexicon® Manufacturer ID	
0x__	Product ID	
0x__	Device ID	
0x00	Command	Request Preset Dump
0x02	Size	LSB
0x00	Size	cont
0x00	Size	cont
0x00	Size	MSB
0x__	Bank	Bank in which requested preset lives.
0x__	Preset	Preset ID
0xF7	EOX	

COMMAND 1: PRESET DUMP

This sysex is transmitted by a MIDI sequencer or by PCM96. The PCM96 may transmit this dump in response to a request or by means of a front-panel action. The PCM96 receiving this dump will store the encapsulated preset data in the designated location.

Byte	Definition	Comments
0xF0	Sysex message	
0x06	Lexicon Manufacturer ID	
0x__	Product ID	
0x__	Device ID	
0x01	Command	Preset Dump
0x__	Size	LSB. Size is variable and is not shown in this example
0x__	Size	cont
0x__	Size	cont
0x__	Size	MSB
0x__	Bank	Bank in which the preset is to be placed.
0x__	Preset	Location in the bank where the preset is to be placed.
...	Preset data	Nibbleized preset data.
0xF7	EOX	

COMMAND 2: REQUEST PRESET BANK DUMP

When this command is received by the PCM96, it will respond with a series of preset dumps for all presets in the bank. Blank presets will be transmitted in a special form. Only presets from User banks may be requested. Factory banks will not be transmitted.

Byte	Definition	Comments
0xF0	Sysex message	
0x06	Lexicon® Manufacturer ID	
0x__	Product ID	
0x__	Device ID	
0x02	Command	Request Preset Bank Dump
0x01	Size	LSB
0x00	Size	cont
0x00	Size	cont
0x00	Size	MSB
0x__	Bank	Bank to fetch
0xF7	EOX	

THE ALGORITHMS

CHAMBER (STEREO AND MONO)

Chamber is a complex miniature-space effect resembling an echo chamber at its smaller settings and, at its larger ones, a small performance space with a more rapid build-up of reflection density than a hall. Reverberant tails are randomized.

RANDOM DELAY (STEREO AND MONO)

Random Delays provide no-holds-barred control over delays. These algorithms feature one delay line per input channel. Each delay line has two outputs, called “voices.” Each voice has independent delay time (up to and over 9 seconds, plus an additional second provided by the randomizers described in the next paragraph), output level, feedback control, filtering (independent filters for feedback and output), and panning. Random Delays have the same diffusion controls as Dual Delays.

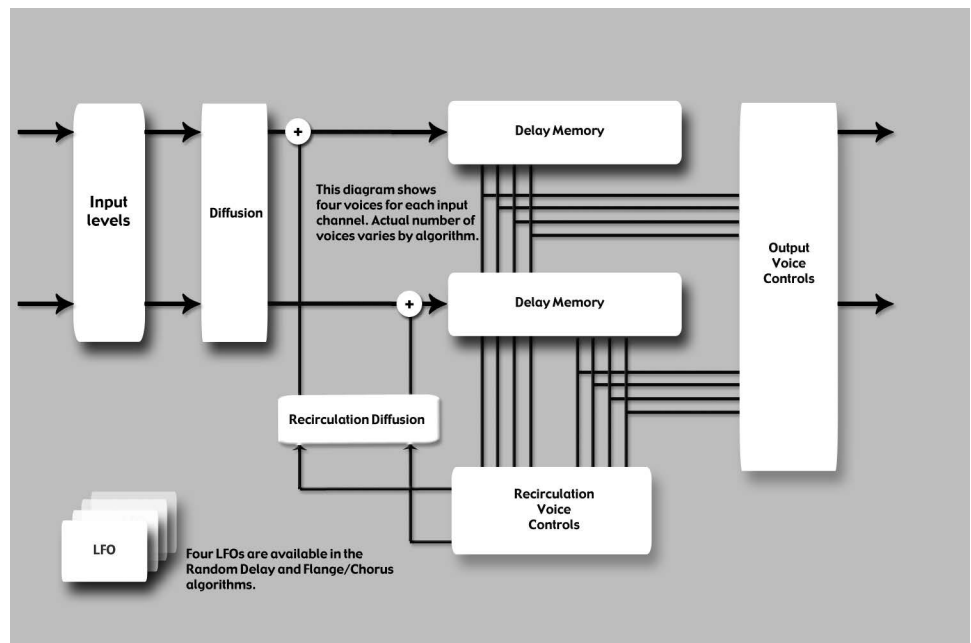

In addition to this basic voice architecture, Random Delays feature four randomizers that provide up to one second of additional delay time for each voice. Voices can be assigned to either randomizer, or to no randomizer at all.

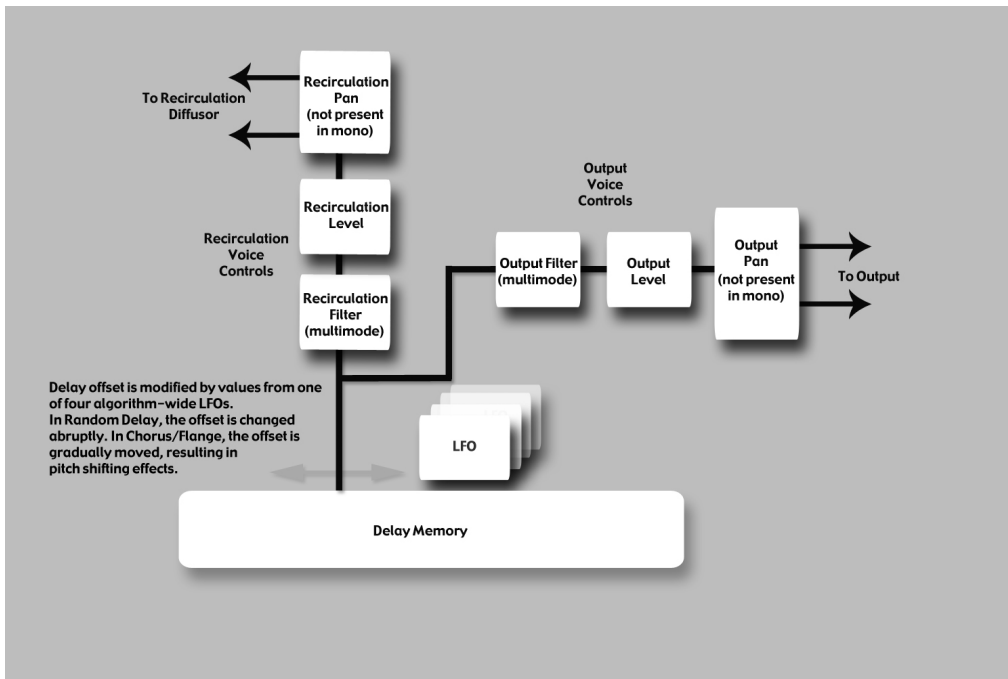

Random Delays are similar to Simple Delays, but are especially useful for:

- Multitap Tape Loops
Feedback can be used to recirculate delays. Appropriate use of highpass and lowpass filters emulates the bandpass effects of multi-generational tape loops (hiss not included). Feedback diffusion allows emulation of azimuth misalignment – a hallmark of the sound.
- Early Reflection Modeling
Although different in scope from Lexicon® Ambience algorithms, Random Delays can be used to place early reflections in stereo or surround fields.
- Modulated Delays
Delay times may be modulated by signal level, LFO or random values.

HALL (STEREO AND MONO)

A hall is the principal venue for classical ensembles, but has proven to be useful for all types of music. A hall is comparatively large, with wall-to-wall distances that are typically several tens of meters. Smaller halls may be used for smaller ensembles. The characteristic sound of a hall includes very low initial reflection density, with little reflection energy before 60-100 milliseconds. Density buildup is more gradual, because of the larger distances between reflecting surfaces. Reverberation time is somewhat longer as well. Finally, in most halls lower frequencies reverberate longer than higher frequencies.

This new hall algorithm shares these basic characteristics with Random Hall and Concert Hall, but is smoother with a more even decay. Its initial density is also lower than Random Hall so it may be a better choice when the reverberation needs to be unobtrusive.

RANDOM HALL (STEREO AND MONO)

Random Hall is a hall effect with gradual build-up, well suited to complex sounds like orchestral music. Its reverberators change over time in controlled random ways to avoid the buildup of tinny, grainy, metallic, or other colorations. The modulation can be noticeable and is often a desirable effect.

The early reflections are user adjustable in amplitude and delay. Some skill is needed to set useful reflection patterns. The pattern can be expanded or contracted in time using the “Delay Master” control, and the overall level of the pattern can be set with the “Early Level” control.

A hall is the principal venue for classical ensembles, but has proven to be useful for all types of music. A hall is comparatively large, with wall-to-wall distances that are typically several tens of meters. Smaller halls may be used for smaller ensembles. The characteristic sound of a hall includes very low initial reflection density, with little reflection energy before 60-100 milliseconds. Density buildup is more gradual, because of the larger distances between reflecting surfaces. Reverberation time is somewhat longer as well. Finally, in most halls lower frequencies reverberate longer than higher frequencies.

One of its charms is a bit of irregularity in the decay. In some cases (very small rooms with precisely-pitched instruments), this modulation may not be the best choice. But in general, this is a time-tested reverberator.

PLATE (STEREO AND MONO)

The Plate programs mimic the sounds of metal plates, with high initial diffusion and a relatively bright, colored sound. For this reason, they are good choices for percussion. They are designed to be heard as part of the music, mellowing and thickening the initial sound itself. The Plate sound is what many people associate with the word reverb, and it is useful for all popular music.

DUAL DELAY (STEREO AND MONO)

Dual Delay feature two delay lines for each input channel. Each delay line has a single output or “voice.” Each voice has independent delay time (up to 2 seconds), output level, feedback control, filtering, and panning.

The feedback path includes highpass and lowpass filters. In addition to this basic voice architecture, Dual Delays feature parameters that provide expanded diffusion controls.

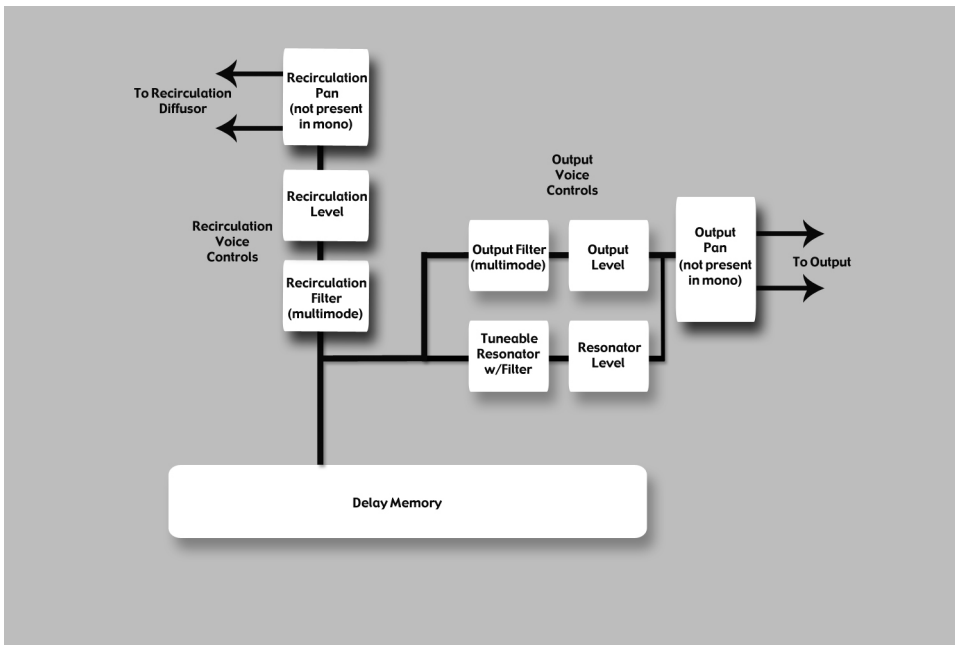

RESONANT CHORDS (STEREO AND MONO)

The Resonant Chord algorithm uses impulsive energy at the inputs to excite six resonant voices (notes). The level, pitch, duration, and high-frequency cutoff of the overtones for each voice are separately controllable. Each voice can be panned independently. The voices resonate to some degree with any input, but the most effective excitation contains all frequencies, like percussion. Other instruments may give a quality of tonal ambience in which certain notes rise ethereally from the background. The output of the resonator is then fed into a stereo plate reverb effect.

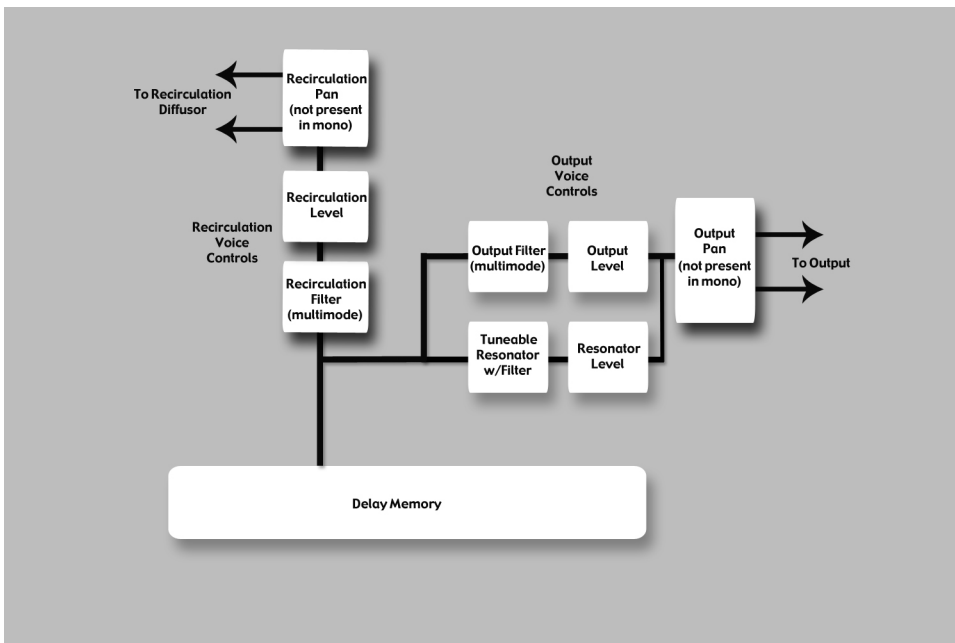

The two algorithms differ in the way pitches are assigned to the resonators. In Res1>Plate, pitches are assigned to the six voices chromatically, in a round-robin. For example, if MIDI note numbers are used to assign pitch, the resonators will constantly be re-tuned to the pitches of the last six MIDI notes received. (This can produce an effect similar to playing a piano with

the sustain pedal depressed.) In Res2>Plate, pitches are assigned to the six resonators diatonically, harmonized with the key, scale, and root of your choice. If MIDI note numbers are used to assign pitch, the resonators will constantly be re-tuned to harmonize with the incoming notes.

CHORUS/FLANGE (STEREO ONLY)

Chorus/Flange is quite similar to other delay algorithms in the PCM96. It has four delay voices per channel, each delay voice having over 9 seconds of delay. The delays may be independently panned and filtered. The difference is in the modulation aspect. The same LFO modulators are available as in Random Delay, but the voices react differently. In Random Delay, the voices move abruptly. In Chorus/Flange, they move very gradually, with noticeable (and desirable) pitch effects as they move. For the chorus effect, the voices move somewhat independently, yielding a thickening effect without too much filtering. For the flange effect, voices are generally paired at close intervals. As they move, a noticeable comb-filtering takes place due to cancellation. The voices are often fed back, nearly to the point of instability.

CONCERT HALL (STEREO ONLY)

This is a recreation of one of Lexicon[®]'s oldest algorithms. It was an essential part of many of the mixes of the late seventies and eighties. It is a less-dense reverb, allowing it to add lushness to a mix without stepping on the dry source material. It also has quite noticeable modulation, causing strong pitch effects at higher settings. The reverb tail has a life of its own, desirable in pop music, less so in jazz or classical applications.

ROOM (STEREO AND MONO)

A room is similar to a reverb in that it is used to create the illusion of space. However it differs in important ways. A room is comprised of a selectable early impulse taken from actual room measurements. There are several categories of responses, including small rooms, large rooms and odd rooms (impulses from unconventional sources). There are parameters to allow adjustments to this response, including scaling and reversing the response. In many cases this is sufficient. A reverb tail can be added to the room by means of an included small reverb algorithm.

Lexicon reverbs are renowned for smooth tails and controlled frequency response. However, in many cases the earlier components are more important. This may be true for some forms of popular music and is even more true for post-production. In these cases, specific types of spaces need to be invoked for convincing dialog and effects.

SIGNAL GENERATOR

This algorithm is used to generate test signals. These signals may be used both for building presets and for testing aspects of recording studio functionality.

THE PARAMETERS

The PCM96 contains hundreds of presets, covering just about every possible need. But you can refine and customize any preset by adjusting its **parameters**. Parameters are the building blocks within each preset that determine how it sounds and behaves.

Each **algorithm** contains a set of parameters, and a variety of those parameters (sometimes from more than one algorithm) are combined to create a preset. You can edit a machine preset's parameters via the A, B, and C knobs (which control the **Soft Row**; see "Editing a Preset" on page 9 for more information), or you can access parameters located in sub-menus via the Machine menu (see "Machine Menu" on page 20 for more information). You can edit a system preset's parameters by accessing them via the preset's sub-menus, or you can edit the parameters in the individual machine presets contained within the machine preset.

Below are all the algorithm parameters you can edit in the PCM96. Note that sometimes parameter names are abbreviated when they appear onscreen (for example, Delay Level Master may appear as DlyLvlMaster), and they may have prefixes indicating what channel they control (for example, Level may appear as RightInLvl, or OutLvl).

To see the parameters in context, see "PCM96 Menu Navigation Maps" on page 39.

Bandwidth

This parameter lets you set the bandwidth of a multimode filter. Bandwidth is specified in octaves or fractions thereof.

Bass Boost (Room)

This parameter is closely tied to the Bass Crossover parameter. It controls the boost (or cut) of signal below that crossover.

Depending on the type of impulse response selected, the listener may become aware of an excess or insufficiency of low frequency output. This parameter may be used to correct the frequency response.

Bass Crossover (BassXOver)

The Bass Crossover parameter is closely tied to the BassRT parameter. It represents the frequency below which BassRT has an effect. Note that there are two of these parameters in the Room algorithm. One is tied to BassRT, the other is found in the Pattern settings menu and affects the BassBoost.

BassRT

This parameter controls bass reverb time. It is closely associated with the Bass Crossover and MidRT parameters. BassRT is a multiple of MidRT that applies to signal below the frequency described by Bass Crossover. If BassRT is less than 1.0, then the low frequency part of the reverb tail will be shorter than the midrange part. If BassRT is greater than 1.0, then the low frequency part of the tail is longer.

Category (Room)

This parameter lets you select a specific category from which a room response may be chosen. Changes here have a direct effect on the Pattern Selector parameter.

Chorus Depth (Concert Hall)

This parameter controls the amount of randomization of the chorus tap. Higher values are generally preferred in order to minimize reverb coloration. Pitch effects may result and are closely tied to the Reverb Chorus Rate parameter.

Chorus Rate (Concert Hall)

This parameter controls the rate at which the reverb chorus is run. Low values may cause a barely-noticeable undulation. Higher values will cause noticeable wobble in fixed-pitch instruments such as piano. It is closely tied to the Reverb Chorus Depth parameter.

Definition

Definition controls the density of some reverbs. Higher values result in lower density.

Delay Feedback Master

Controls all delays in the algorithm. Each voice has its nominal feedback gain adjusted by this percentage.

Delay Level Master

Controls all delays in the algorithm. Each voice has its nominal gain value adjusted by this percentage.

Delay Time (Echo Delay)

Delay time defines the time offset of a delay voice in milliseconds or in fractions of tempo (quarter note, eighth note), which is defined by the tap tempo or by midi tempo. It is used in many of the algorithms, not just the delays. In all cases, it does the same thing.

Delay Time Master

Controls all delays in the algorithm. Each voice has its nominal delay time adjusted by this percentage.

Delay Wander

This parameter determines the amount of additional delay that the LFO process can add to a voice's offset.

Diffusion

Input diffusion is the first part of processing for any signal entering a reverb or delay. It can be described as a smearing or softening of the signal and is typically used to lessen the impact of strong transients.

Bass Crossover (Bass XOver) (Room)

This parameter is closely tied to the Early Bass Boost parameter. It represents the frequency below which early bass boost has an effect.

Feedback

This controls the amount of echo output that is fed back to the input of the echo buffer.

The actual feedback level is modified by the Master Echo Feedback parameter, if present. The master value is a percentage (0-100%) that is applied to the Echo Feedback level.

Feedback Diffusion

Feedback Diffusion is similar to Input Diffusion, except that it is applied to a delayed signal that is being added back into the input.

Feedback Level

This parameter determines the feedback level for a particular voice. It is controlled independently of the voice's output level.

Feedback Pan

Routes the post-filter delay voice back to the inputs of the delay lines.

Frequency

This parameter lets you set the cutoff frequency of the multimode filter. The audible effect of this is determined by the Type parameter.

Front Early Level

This parameter acts as a master control for any early signals going to the output channels. Early signals include echoes, reflections, and the room reflection patterns.

Infinite

This parameter captures the reverb tail as an infinite loop. This may be useful in music, where a note or chord can be extended. It is also useful in post-production for creating ambience backgrounds.

Input Level

Input Level controls the amount of signal admitted into the process from a single input channel.

Input Pan

Routes the signal from an input channel into the algorithm in such a manner as to alter its apparent location.

Level

This parameter acts as a master control for reverb signals going to the output channels. It is used for all reverbs.

LFO Rate

Set the speed of an LFO in Hz.

LFO Waveform Type

Set the shape of the wave the LFO will follow.

Master Echo Delay

Controls all echo voices in the algorithm. Each echo delay has its nominal time adjusted by this percentage.

Master Echo Feedback

Controls all echo voices in the algorithm. Each echo feedback has its nominal gain adjusted by this percentage.

Master Reflection Delay (Reflection Time Master)

Controls all reflection delays in the algorithm. Each reflection delay voice has its nominal delay time adjusted by this percentage.

MidRT

MidRT is the mid frequency reverb time. As such, it is one of the primary controls affecting the length of the reverb tail. At low values, it models a space with absorbent walls—a signal won't bounce many times before it dissipates. At high values, the walls are flat and extremely reflective. A signal lives a long time before dying away.

The parameter most closely associated with MidRT is Size. A large room size with a small MidRT can easily have the same decay time as a small room with a large MidRT. The value that is actually displayed is an approximate reverb time based on both of those values.

Mix (Wet Dry Mix)

Mix is the proportion of wet (processed) signal to dry (unprocessed) signal.

Output Level

Output Level controls the amount of post-mix signal emitted onto a channel of output.

Pan

Routes the post-filter delay voice across the left-right soundstage.

Pattern

Selects a space available in the selected Category (see Category parameter).

Reflection Delay (Delay Time)

A reflection delay is a delay tap taken from one of the inputs and sent to one of the outputs. It is often called a delay voice. Depending on the algorithm, there may be one or more reflection delays for each input channel. Some of the delays may mix their outputs to the same channel (left to left) and some may go cross-channel (left to right).

Reflection Gain (Level)

Each Reflection Delay voice also has a gain value. This gain is controlled by the Reflection Gain parameter.

Resonance

This parameter determines at which frequency the delay voice resonates.

Resonance Detune Master

Controls detuning of all voices in the algorithm. Each voice has its nominal detune adjusted by this percentage. Includes a built-in ducker that attenuates

the delay output whenever signal is present at the input. This can be used to keep the original signal from being muddled up by delay repeats.

Resonance Filter Master

Controls all voices in the algorithm. Each voice's resonator has its nominal cutoff frequency adjusted by this percentage.

Resonance Master
Controls all voices in the algorithm. Each voice has its nominal resonance adjusted by this percentage.

Resonance Tuning Master

Affects all voices in the algorithm. Each voice has its nominal resonance adjusted by this value. In the musical world, the tuning reference is A=440. This means that the note A (above middle C) is equivalent to 440 Hz. Changing the master tuning causes all notes to be sharp or flat.

Resonator Detune

This parameter acts as an adjustment to the specified frequency for the voice's resonator. The calculation of cents yields a ratio which is used to modify the specified frequency of the voice. This parameter is modified by the Master Detune parameter.

Resonator Filter Freq

This parameter controls a lowpass filter inside the resonator.

Resonator Frequency

This parameter determines at which frequency the delay voice resonates. The action of this parameter is determined by the state of the Resonance Mode parameter. When a frequency is calculated for this parameter, it must then be affected by the value of the Master Tuning parameter.

Reverb PreDelay (Predelay)

This is a delay that's added to the diffused signal before it enters the main part of the reverb. For all intents, it may be considered as delay that is added to the reverberated signal. It is used to temporally separate the reverb from the dry signal.

Reverb Spin (Spin)

This is usually simply called spin. It controls the speed of the reverb randomizer. Spin is also connected with the Reverb Wander parameter

Reverb Time Hi Cut

This parameter, also known as Hicut or RTHC is a low-pass filter in the recirculating part of the reverb. It represents a frequency above which the tail dies away more quickly. In some ways, it represents the opposite end of the scale from BassRT, and may be considered an analog of air absorption. It is also closely tied to the Hi Cut Damping parameter.

Reverb Wander

This parameter (also known as just Wander), along with Reverb Spin, is used to control the reverb randomizer. It controls the maximum size of randomizer steps, and is expressed in a time value (typically milliseconds).

Room Size

Room Size corresponds roughly to the length of the longest wall of a rect-

angular room. In a more general sense, it corresponds to the overall dimension of some mythical space. This space has a geometry that causes sound to bounce around. When the room size is small, the “walls” of this space are closer together and the resultant reflection density increases. When the room size is large, that density decreases. The most natural reverbs use room sizes that vary from about 24 meters to 45 meters or so, but there are many useful reverbs that are outside of this range.

There is a relationship between this parameter and the MidRT parameter. Please see the MidRT parameter for clarification.

RtHC Damping

The damping parameter is closely tied to the RTHC parameter. It controls the strength of the hi frequency absorption and has three values: Light, Normal, and Heavy. The normal value gives filter response identical to previous Lexicon® reverbs. The other values should be self-descriptive.

Scale

This parameter is used to modify the overall time of the selected early impulse. It is a multiplier that goes from 0.5x to 2.0x. The actual time of the responses varies from response to response. The Early Scale parameter simply scales that amount of time. It's fair to describe this a “rubber-banding” the impulse response.

Selected LFO

This parameter determines which of the available LFOs may be used to control a voice. The voice may use the LFO output or the inverted LFO output.

Shape (Early Shape)

The Shape parameter is closely tied to the Spread parameter. Shape controls how energy is injected into the reverberator. A low value means that sound enters the reverb at the beginning of the spread window. A high value means that most sound moves into the reverb at the end of the spread window. A value somewhere in the middle means that sound enters the reverb evenly across the spread window.

Tip: Shape will not have this effect if spread is at its minimum value. But even then, it can make a difference. In this case, it affects reverb timbre and density. Higher values of shape will be both darker and denser, although the effect is subtle.

Shelf

This parameter effects all filter types. It allows a certain amount of unfiltered audio to be combined with the filtered audio. This effectively lowers the effect of the filter. Another way of looking at it is that it lessens the normal filter slope of 12 dB per octave. Unlike the traditional biquad filter, the shelf is effective for all filter forms.

Signal Event Freq

Changes the rate of discreet signals from the signal generator. This only has an effect when the signal type is set to sweep tones or pink click.

Signal Frequency

Changes the frequency of the signal generator sine wave. This only has an

effect when the signal type is set to sine wave.

Signal Type

Selects the type of signal to be created by the signal generator. The types of signal are:

- Sine Wave — When this is selected the signal frequency parameter is used to control frequency.
- Sweep Up — 20Hz to 20KHz sweep. When this is selected the signal rate parameter is used to control rate.
- Sweep Down — 20KHz to 20Hz sweep. When this is selected the signal rate parameter is used to control rate.
- Pink Click — Broadband impulse. When this is selected the signal rate parameter is used to control rate.
- White Noise (correlated) — sends identical white noise to all outputs
- White Noise (decorrelated) — sends decorrelated white noise to all outputs.
- Pink Noise (correlated) — sends identical pink noise to all outputs
- Pink Noise (decorrelated) — sends decorrelated pink noise to all outputs.

Spread (Early Spread)

The spread parameter is closely tied to the Shape parameter. Spread is a window of time during which a signal is injected into the reverb. Shape controls just how the signal is injected during this window.

Tail Width

This parameter is present in all stereo reverbs and rooms. The reverb tail (all components of the reverb except for early reflections, etc.) is passed through a simple 2x2 matrix. This provides an encoding of the tail that dramatically changes its spatial characteristics. The tail can be changed to feel narrower (even down to mono) or wider than normal stereo. There are values for the parameter to encode the tail in such a way that it decodes into surround channels.

The parameter operates in the range of 0 to 360 degrees, with an incremental change of 1 degree. The matrix uses Sine/Cosine rules so that power distribution remains constant. This may be acceptable—even highly desirable—but the mix engineer must fully understand the process and its implications.

This is a powerful tool for audio whose release format is two-channel. It is not useful in any other format. Formats include compact disc and radio/television broadcast. Some of these effects are clear and noticeable without any sort of decoder. Many are even more dramatic when a decoder is in place, such as in a home theater.

Tap Slope

This is an extremely subtle parameter and is useful in only a couple of cases:

- For halls and reverbs with relatively long reverb times, the slope should be slightly positive (0.2 or so). For rooms with very short reverb times, the slope should be slightly negative (-0.2 or so).
- Using a reverb to create a gate effect or to create a pseudo-room sound. MidRT should be at 0. Spread should be fairly high. Shape should be

fairly high. Size should be fairly high. TapSlope should be in the range of (0.5 to 1.0). Play with spread, shape and size to vary the effect.

Type

This parameter lets you configure a filter as any of 4 basic types, in order:

- Lowpass
- Highpass
- Bandpass
- Notch (Band-reject)

The filter provides a subset of filter types available to a Biquad filter.

Wet Dry Mix

Wet Dry Mix is the proportion of wet (processed) signal to dry (unprocessed) signal.

PCM96 MENU NAVIGATION MAPS

PCM96 MENU NAVIGATION MAP - SYSTEM VIEW AND MACHINE VIEW

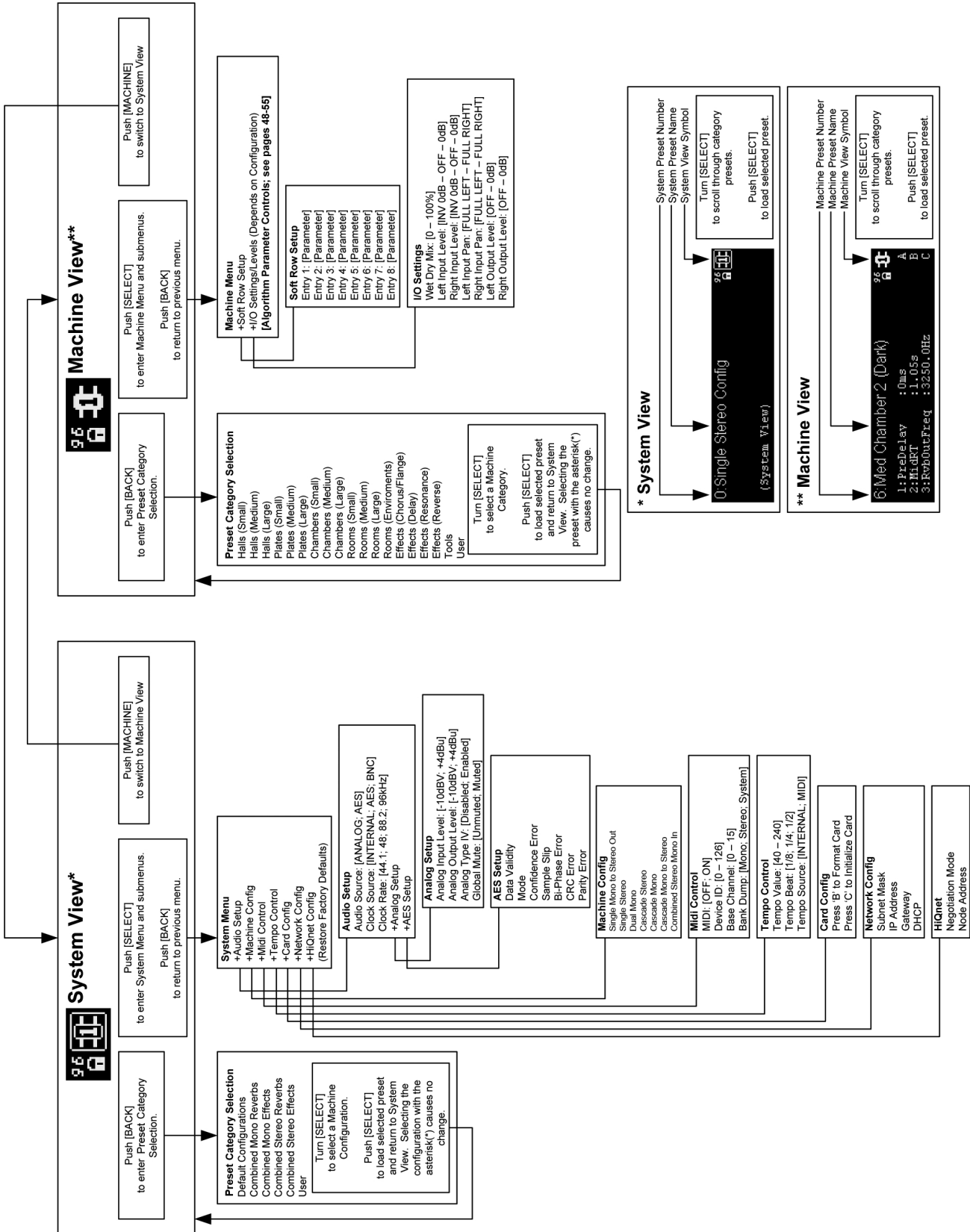

PCM96 MENU NAVIGATION MAP - STEREO HALL ALGORITHMS

Stereo: Hall, Random Hall, Concert Hall and Plate Parameters

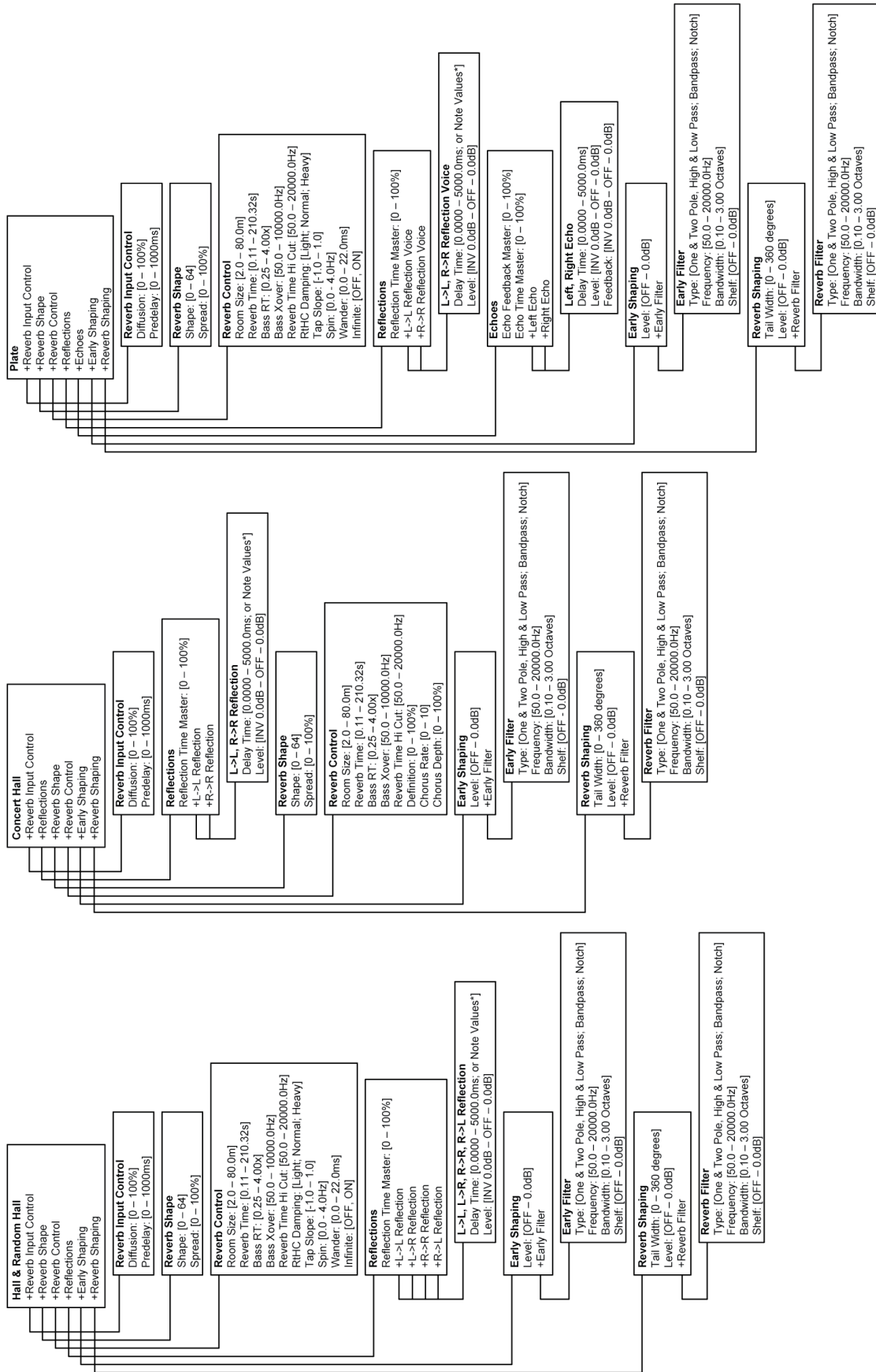

* Press [A] to toggle Delay Time values between Seconds and Note Values.
Note Values: [Half Note, Dotted Quarter, Half Triplet, Quarter Note, Dotted Eighth, Quarter Triplet, 8th Note, Dotted 16th, 8th Triplet, 16th Note, Dotted 32nd, 16th Triplet, 32nd Note]

PCM96 MENU NAVIGATION MAP - STEREO CHAMBER AND ROOM ALGORITHMS

Stereo: Chamber and Room Parameters

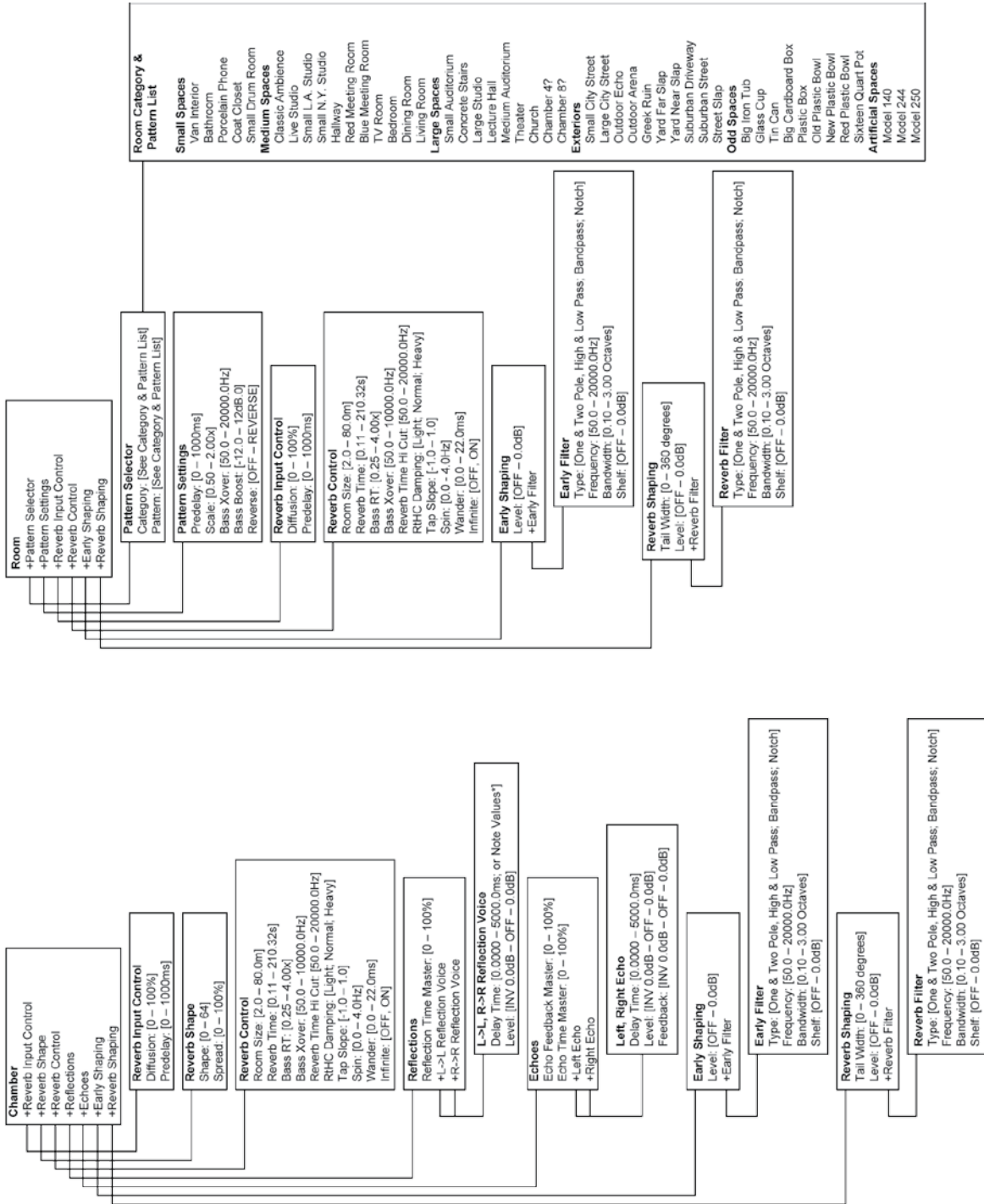

* Press [A] to toggle Delay Time values between Seconds and Note Values.
Note Values: [Half-Note; Dotted Quarter; Quarter-Note; Dotted Eighth; Quarter Triplet; 8th Note; Dotted 16th; 8th Triplet; 16th Triplet; 32nd Triplet; 32nd Note]

PCM96 MENU NAVIGATION MAP - STEREO DELAY ALGORITHMS

Stereo: Dual Delay and Random Delay Parameters

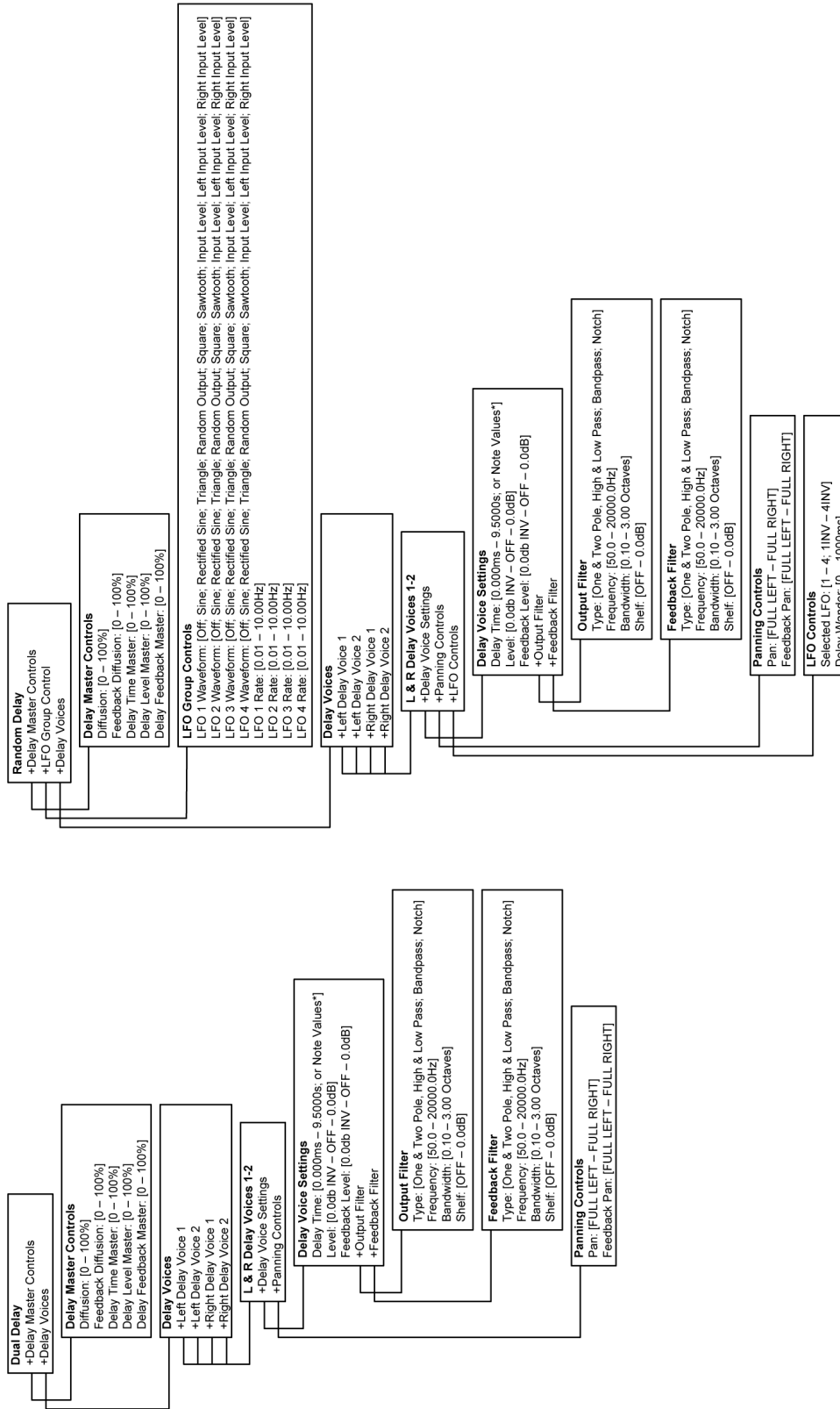

* Press [A] to toggle Delay Time values between Seconds and Note Values.
 Note Values: [Half-Note, Dotted Quarter, Quarter, Half Triplet, Quarter-Note, Dotted Eighth, Quarter Triplet, 8th Note, Dotted 16th, 8th Triplet, 16th Note, Dotted 32nd, 16th Triplet, 32nd Note]

PCM96 MENU NAVIGATION MAP - STEREO EFFECTS ALGORITHMS

Stereo: Chorus/Flange and Resonant Chord Parameters

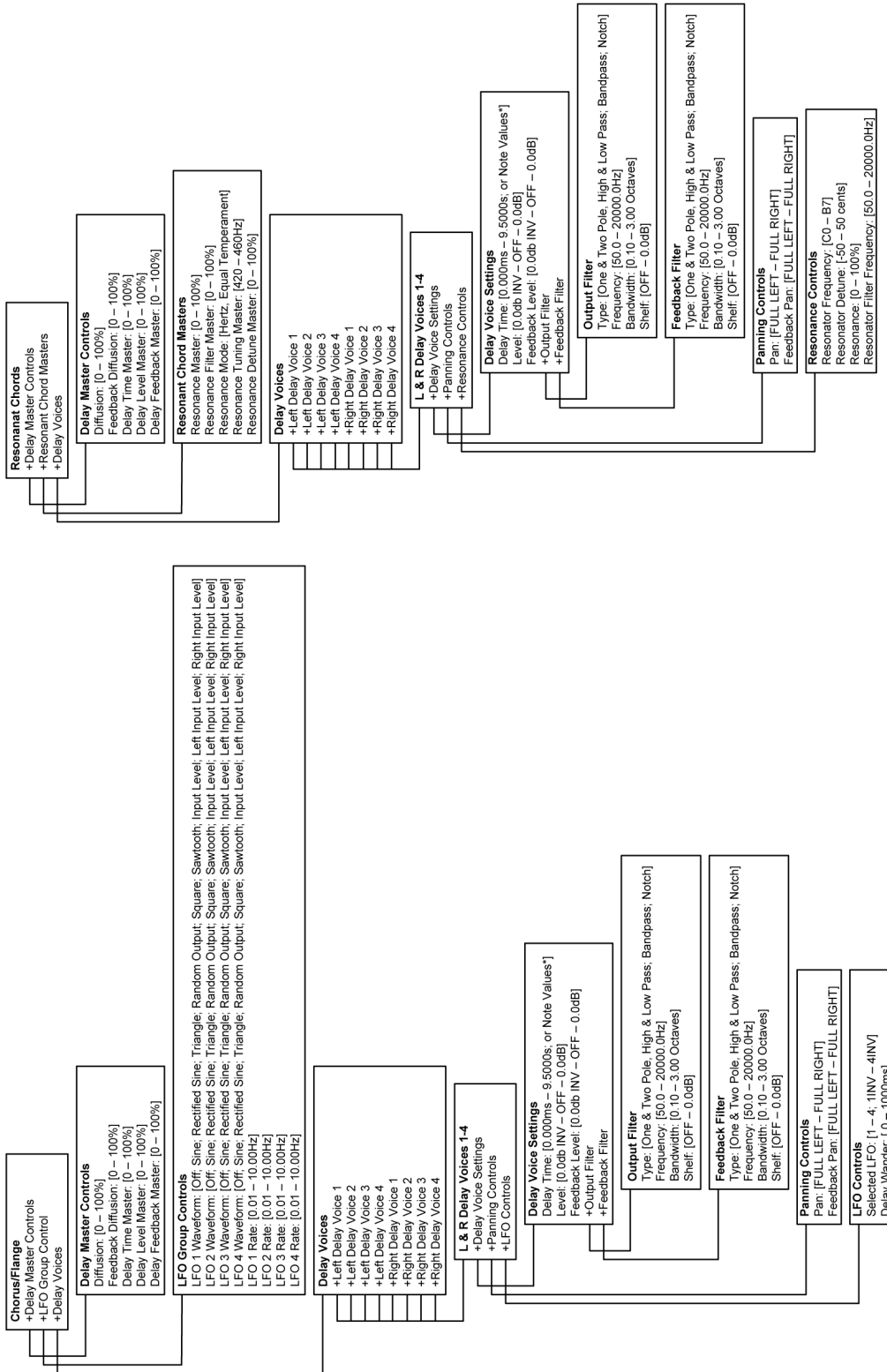

* Press [A] to toggle Delay Time values between Seconds and Note Values.
 Note Values: [Half Note, Dotted Quarter, Half Triplet, Quarter Note, Dotted Eighth, Quarter Triplet, 8th Note, Dotted 16th, 8th Triplet, 16th Note, Dotted 32nd, 16th Triplet, 32nd Note]

PCM96 MENU NAVIGATION MAP - MONO HALL ALGORITHMS

Mono: Hall, Random Hall, Concert Hall and Plate Parameters

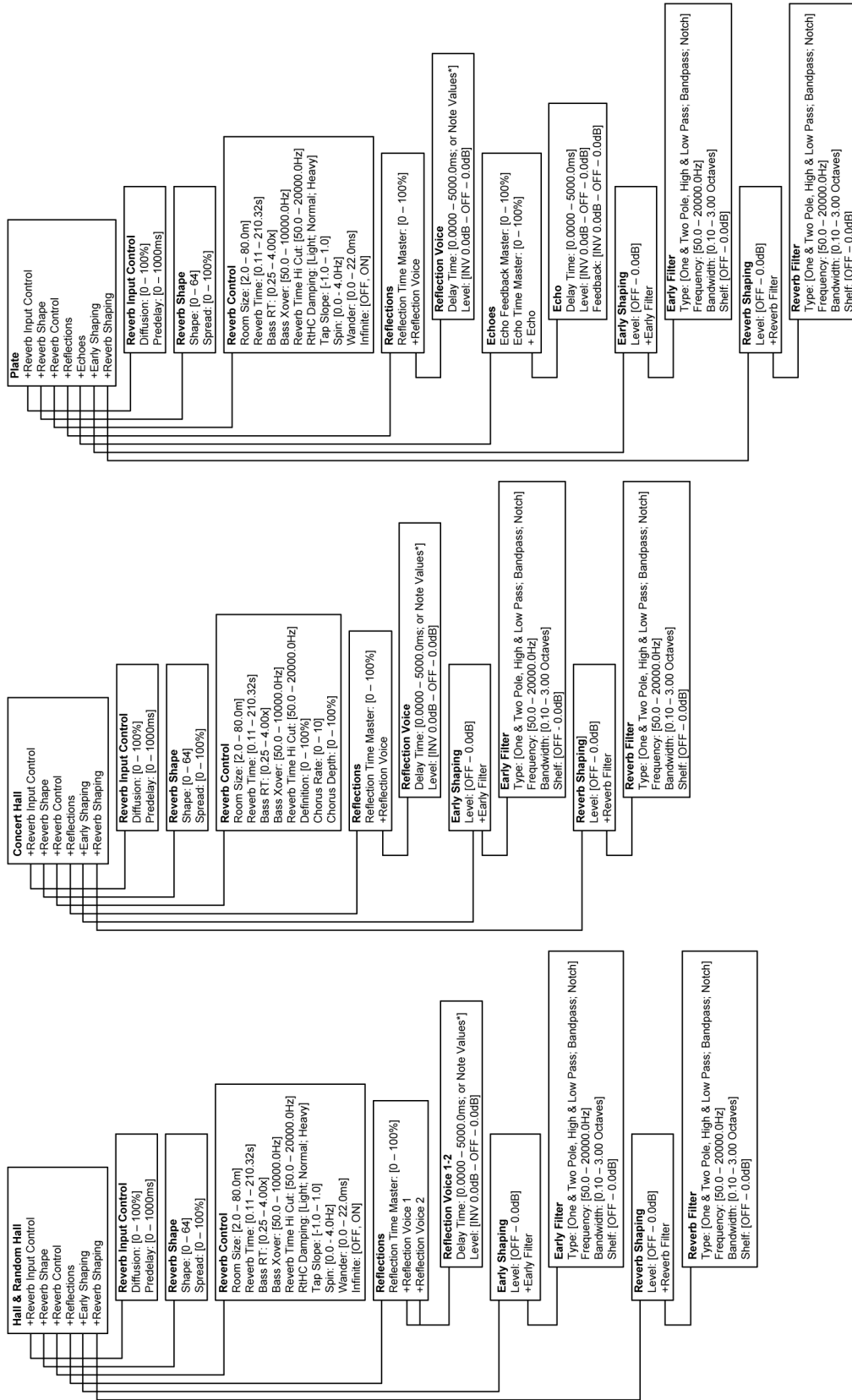

* Press [A] to toggle Delay Time values between Seconds and Note Values.
Note Values: [Half-Note; Dotted Quarter; Half Triplet; Quarter-Note; Dotted Eighth; Quarter Triplet; 8th Note; Dotted 16th; 8th Triplet; 16th Note; Dotted 32nd; 16th Triplet; 32nd Note]

PCM96 MENU NAVIGATION MAP - MONO CHAMBER AND ROOM ALGORITHMS



* Press [A] to toggle Delay, Time values between Seconds and Note Values.
Note Values: [Half Note; Dotted Quarter; Half Triplet; Quarter Note; Dotted Eighth; Quarter Triplet;
8th Note; Dotted 16th; 8th Triplet; 16th Note; Dotted 32nd; 16th Triplet; 32nd Note]

PCM96 MENU NAVIGATION MAP - MONO DELAY ALGORITHMS

Mono: Dual Delay and Random Delay Parameters

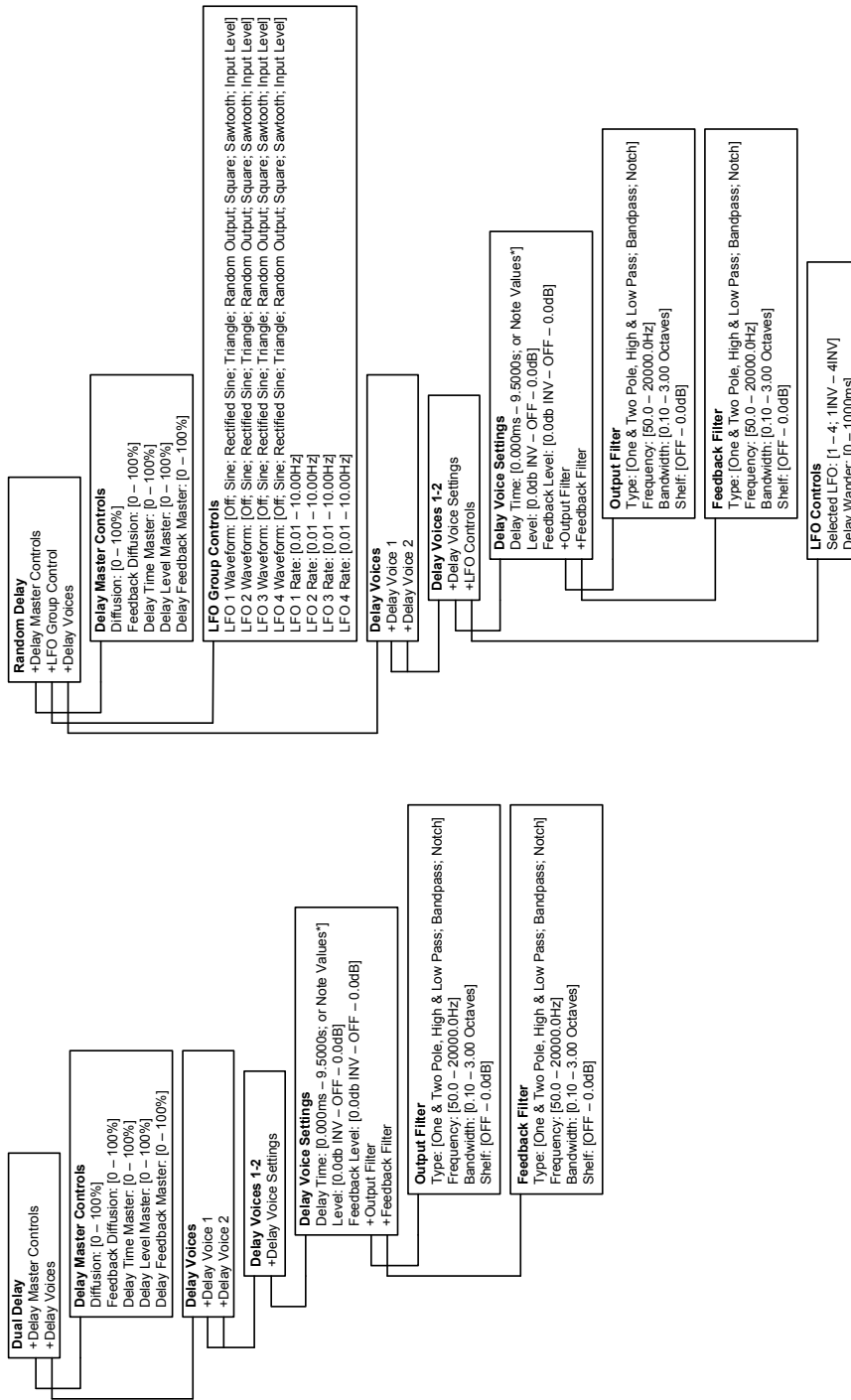

* Press [A] to toggle Delay Time values between Seconds and Note Values.
 Note Values: [Half Note; Dotted Quarter; Half Triplet; Quarter Note; Dotted Eighth; Quarter Triplet;
 8th Note; Dotted 16th; 8th Triplet; 16th Triplet; 32nd Note]

PCM96 MENU NAVIGATION MAP - MONO EFFECTS ALGORITHMS

Mono: Chorus/Flange and Resonant Chord Parameters

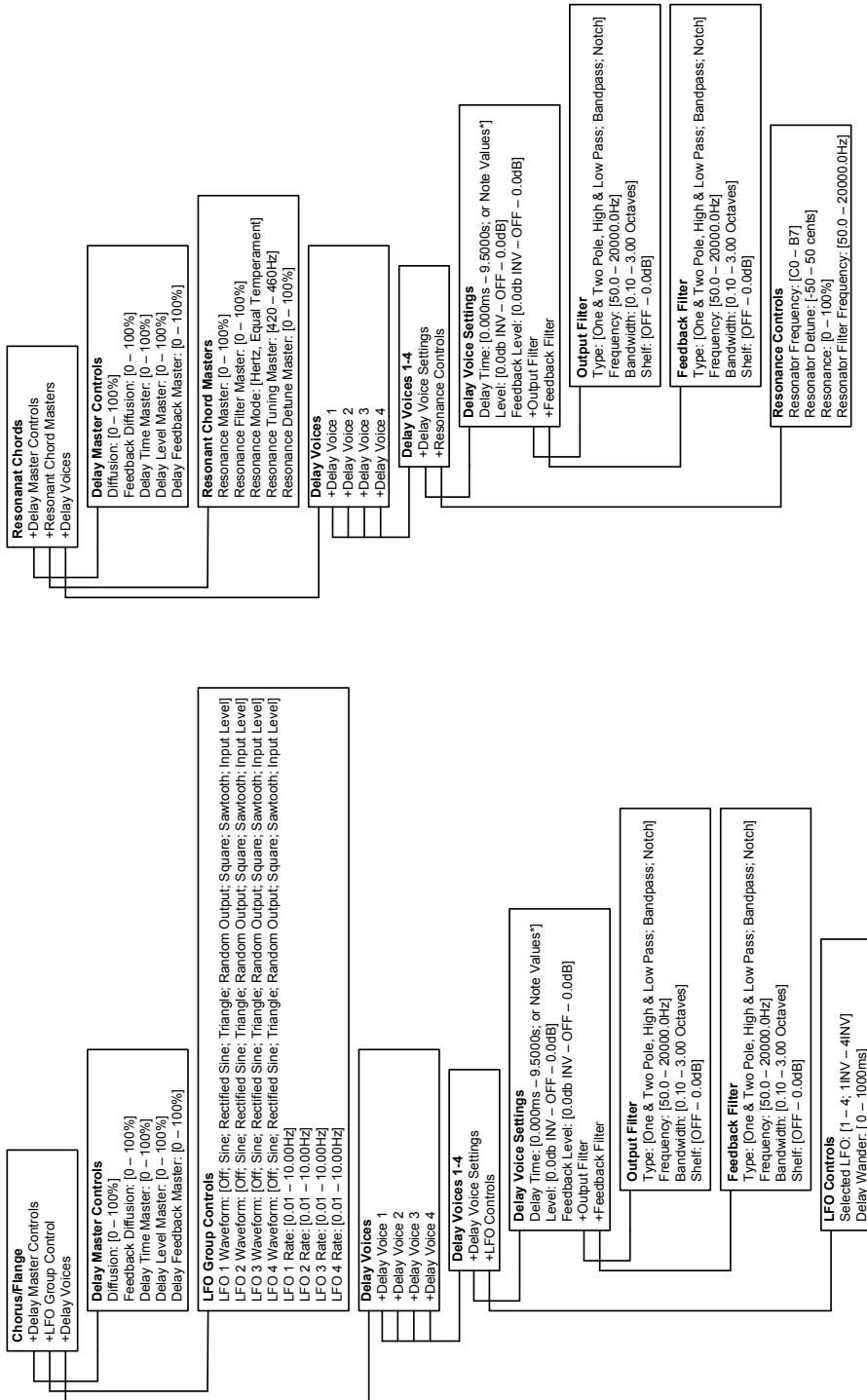

* Press [A] to toggle Delay Time values between Seconds and Note Values.
 Note Values: [Half-Note; Dotted Quarter; Half Triplet; Quarter-Note; Dotted Eighth; Quarter Triplet;
 8th Note; Dotted 16th; 8th Triplet; 16th Note; Dotted 32nd; 16th Triplet; 32nd Note]

SPECIFICATIONS

ANALOG INPUTS

Connectors	Two, Female XLR
Impedance	20K Ohm, balanced
Level (for 0 dbFS)	+4dBu mode: +20dBu -10dBV mode: 8.2dBu
Freq Response @96K	20Hz to 40KHz, +0/-3dB
A/D Conversion	24 bits
A/D Dyn Range	>112 dB unweighted, 115dB A-weighted
THD	<.002% 20 → 20kHz @ +4dBu
Crosstalk @ 1Khz	<-90 dB, 20 → 20k at +20dBu input signal

ANALOG OUTPUT

Connectors	Two, Male XLR
Impedance	30 Ohm, electronically balanced
Level (at 0 dBFS)	+20dBu
Freq Response @96K	20 Hz - 20 kHz, +/- 0.25 dB 20Hz - 40kHz +0/-3dB
D/A Conversion	24 bits
D/A Dyn Range	112 dB unweighted, 115 dB A-weighted
THD	<.002% 20Hz - 20kHz at +4dBu
Crosstalk @ 1kHz	<-90 dB at 20Hz - 20kHz with +20dBu input signal

DIGITAL AUDIO IO

Connectors	One Male XLR Output One Female XLR Input
Format	AES/EBU
Word Size	24 bits

SAMPLE RATES

Internal	44.1kHz/48kHz/88.2kHz/96kHz
Accuracy	within ±50ppm
External	44.1kHz/48kHz/88.2kHz/96kHz
Lock Range	±2% of nominal

PROPAGATION DELAYS (MILLISECONDS)

	44.1 kHz	48 kHz	88.2 kHz	96 kHz
A/D	1.41	1.28	1.25	1.13
A/A	1.64	1.51	1.28	1.18
D/A	1.48	1.36	1.24	1.14
D/D	1.23	1.12	1.15	1.07

SYNCHRONIZATION

TTL Word Clock Input *	75 Ohm, BNC
------------------------	-------------

*Falling edge marks start of frame

CLOCK JITTER

Intrinsic	Exceeds AES3 Amendment 1
Jitter Gain	Exceeds AES3 Amendment 1

CONTROL INTERFACES

MIDI **	In/Out/Thru
---------	-------------

**supports program change

ALGORITHMS

Chamber	Stereo and Mono
Random Delay	Stereo and Mono
Random Hall	Stereo and Mono
Plate	Stereo and Mono
Dual Delay	Stereo and Mono
Resonant Chords	Stereo and Mono
Chorus/Flange	Stereo only
Concert Hall	Stereo only
Room	Stereo and Mono
Hall	Stereo and Mono
Signal Generator	

Storage Media

Type I Compact Flash
Can hold up to 1536 user presets

MACHINE CONFIGURATIONS**44.1K/88.2K**

Two Mono (Super-mono capable)
Single Stereo (Super-stereo capable)
Two Cascaded Mono pairs
Cascaded Stereo
Two Mono cascaded into single Stereo
Dual mono-in/stereo-out with combined outputs
Single Super Stereo
Two Stereo
Dual Super Mono
Four Mono
Two Mono and One Stereo

INTERNAL HARD DISK STORAGE

Internal non-volatile Flash. Can hold 768 user presets.

POWER

Requirements	100-120 / 220-240 VAC 50-60Hz, 20W max
Connector	3-pin IEC

DIMENSIONS/WEIGHT

Rack Units	1U
Size	19.0" W x 1.75" H x 12.5" D (483mm x 44.5mm x 317.5mm)
Weight	8.65 lbs

REGULATORY APPROVALS

FCC	Class A
CE	EN55103-1, EN55103-2
UL	UL1419
cUL	C22.2
TUV	EN60065

ENVIRONMENT

Operating	15° to 35° C
Storage	-30 to 70 °C
Humidity	75% relative humidity max

MIDI IMPLEMENTATION CHART

Function		Transmitted	Recognized	Remarks
Basic Channel	Default	X	1-16	
	Changed	X	X	
Mode	Default	X	N/A	
	Messages	X	X	
	Altered	X	X	
Note Number	True Voice	X	X	
Velocity	Note ON	X	X	
	Note OFF	X	X	
After Touch	Keys	X	X	
	Channel	X	X	
Pitch Bend		X	X	
Control Change		OX 32 OX 48-55	OX 32 OX 48-55	Bank Change
Program Change		OX 1-127	OX 0-127	
Bank Select		O	O	
System Exclusive		Device ID	Device Inquiry	Device ID
System Common	Song Position	X	X	
	Song Select	X	X	
	Tune Request	X	X	
System Real Time	Clock	X	X	
	Commands	X	X	
Aux Messages	Local ON/OFF	X	X	
	All Notes OFF	X	X	
	Active Sensing	X	X	
	System Reset	X	X	
Notes				

Mode 1: OMNI ON, POLY
Mode 3: OMNI OFF, POLY

Mode 2: OMNI ON, MONO
Mode 4: OMNI OFF, MONO

O : Yes
X : No

OX : Selectable



10653 South River Front Parkway, Suite 300
South Jordan, UT 84095, USA
Phone: (801) 566-8800
PCM96

Questions or comments?
Email us at: customer@lexiconpro.com
or visit us online at www.lexiconpro.com