

zoom®

USB3.0 Audio Converter **UAC-2**

Operation Manual

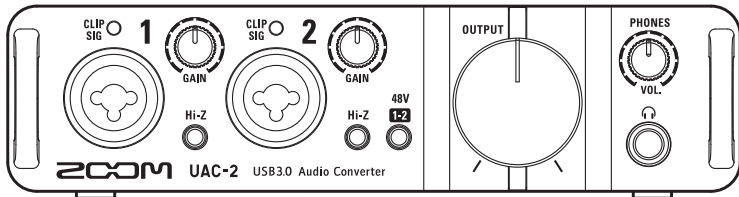

© 2015 ZOOM CORPORATION

Copying or reprinting this manual in part or in whole without permission is prohibited.

Contents

Introduction	2	Playback	13
Usage and Safety Precautions	3	Connecting MIDI Devices	15
Part Names	4	Restoring Factory Default Settings	16
Connecting with a Computer	6	Troubleshooting	17
iPad connection (class compliant mode).....	8	Specifications	18
Recording	10		

Introduction

2-in/2-out USB3.0 Audio Converter

The **UAC-2** is an audio converter with a SuperSpeed USB3.0 interface.

In addition to supporting Windows and Mac, using class compliant mode it can also be connected to an iPad. Since it also supports recording and playback at up to 24-bit/192kHz, it can also be used for the playback of high-resolution sound sources delivered with superior audio quality over the Internet.

Attention to audio performance

The entire system reproduces the original audio faithfully. An asynchronous transfer system that is not impacted by computer jitter is used along with the latest AD/DA converter, which supports 192kHz.

Built-in high-performance mic preamps

The high-performance mic preamps are based on those developed for our H Series. Each input also supports Hi-Z connections. The gain can be raised by up to 60 dB, and +48V phantom power can be supplied.



UAC-2 MixEfx dedicated mixer application

Use this application to make internal mixer and monitoring effect settings. For details about **UAC-2 MixEfx**, see the ZOOM website (<http://www.zoom.co.jp/downloads/>).



Usage and Safety Precautions

SAFETY PRECAUTIONS

In this operation manual, symbols are used to highlight warnings and cautions that you must read to prevent accidents. The meanings of these symbols are as follows.

	Something that could cause serious injury or death
	Something that could cause injury or damage to the equipment

Other symbols used

	An action that is mandatory
	An action that is prohibited

Warnings

Alterations

- Do not open the case or modify the product.

Operation using an AC adapter

- Never use any AC adapter other than a ZOOM AD-14.
- Always hold the AC adapter itself when disconnecting it from an outlet.
- Do not do anything that could exceed the ratings of outlets and other electrical wiring equipment or supply power other than AC100V.
- Before using the equipment in a foreign country or other region where the electrical voltage differs from AC100V, always consult with a shop that carries ZOOM products and use the appropriate AC adapter.

Precautions

Product handling

- Do not drop, bump or apply excessive force to the unit.
- Be careful not to allow foreign objects or liquids enter the unit.

Operating environment

- Do not use in extremely high or low temperatures.
- Do not use near heaters, stoves and other heat sources.
- Do not use in very high humidity or where it could be splashed by water.
- Do not use in places with frequent vibrations.
- Do not use in places with much dust or sand.

Connection cables and input/output jacks

- Always turn the power OFF for all equipment before connecting any cables.
- Always disconnect all connection cables and the AC adapter before moving the unit.

Volume

- Do not use at a loud volume for a long time.

Usage Precautions

Interference with other electrical equipment

In consideration of safety, the **UAC-2** has been designed to minimize its emission of electromagnetic waves and to suppress interference from external electromagnetic waves. However, equipment that is very susceptible to interference or that emits powerful electromagnetic waves could result in interference if placed nearby. If this occurs, place the **UAC-2** and the other device farther apart. With any type of electronic device that uses digital control, including the **UAC-2**, electromagnetic interference could cause malfunction, corrupt or destroy data and result in other unexpected trouble. Always use caution.

Cleaning

Use a soft cloth to clean the exterior of the unit if it becomes dirty. If necessary, use a damp cloth that has been wrung out well. Never use abrasive cleansers, wax or solvents such as alcohol, benzene or paint thinner.

Temperature considerations

Continuous use of this interface for long periods of time, for example, might cause it to become warm. This is normal as long as it does not become too hot to touch.

Breakdown and malfunction

If the **UAC-2** should malfunction or operate abnormally, disconnect it immediately. Then, contact the retailer where you purchased it or Zoom support and provide the following information: product model, serial number and details of the symptoms of malfunction or abnormal operation, as well as your name, address and telephone number.

Copyrights

- Windows® is a registered trademark of Microsoft® Corporation.
- Mac®, iPad® and Lightning™ are trademarks or registered trademarks of Apple Inc.
- MIDI is a registered trademark of Association of Musical Electronics Industry (AMEI).
- All other product names, trademarks and company names in this document are the property of their respective owners.

Note: All trademarks and registered trademarks in this document are for identification purposes only and are not intended to infringe on the copyrights of their respective owners.

Recording for any purpose other than personal use from copyrighted sources, including CDs, records, tapes, live performances, video works and broadcasts, without permission of the copyright holder is prohibited by law.

Zoom Corporation will not assume any responsibility related to infringements of copyrights.

Part Names

■ Top Panel

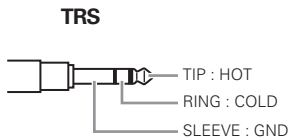
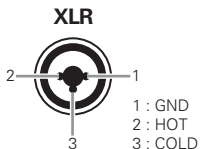
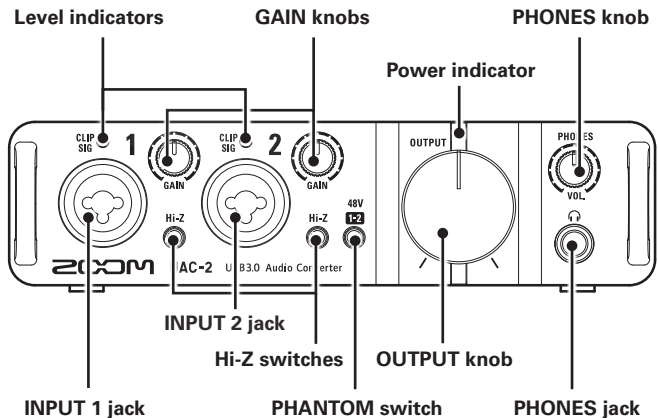

■ Rear Panel

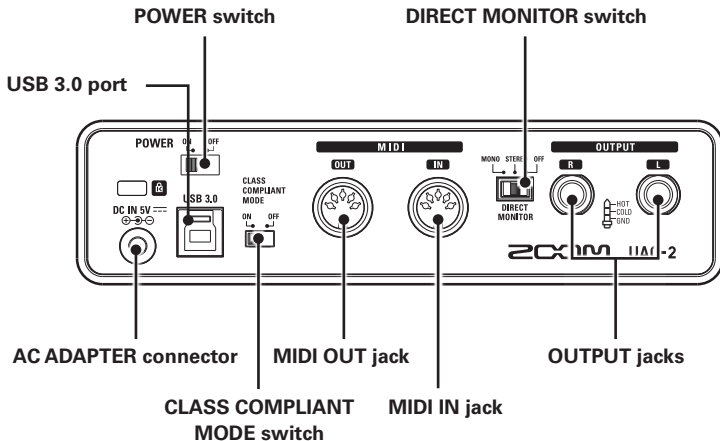

Connecting with a Computer

■ Installing the Driver

Do not connect the **UAC-2** until installation completes.

1. Download the ZOOM UAC-2 Driver from <http://www.zoom.co.jp/downloads/> to your computer.

NOTE

- You can download the latest ZOOM UAC-2 Driver from the above website.
- Download the driver for the operating system that you are using.

-
2. Launch the installer and install the driver.

Follow the instructions that appear on screen to install the ZOOM UAC-2 Driver.

NOTE

- See the Installation Guide included in the driver package for detailed installation procedures.

■ Turning the Power ON

Before turning the power on, minimize the volumes of the **UAC-2** and connected devices.

1. Use a USB cable to connect the **UAC-2** and the computer.

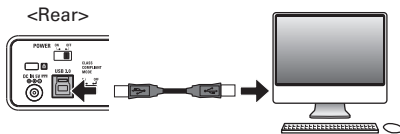

NOTE

- Although also compatible with USB2.0, USB3.0 connection enables operation with even higher performance.

2. Set  to ON.

NOTE

- The **UAC-2** cannot be used if it is not connected to a computer.
- If the power supplied by the USB bus is low, or you want to operate the unit with an adapter, use the optional AD-14 adapter that was designed for use with this unit.

3. Set the **UAC-2** as the computer sound device.

NOTE

- See the Installation Guide included in the driver package for procedures to set the sound device in different operating systems.

iPad connection (class compliant mode)

By using the optional power adapter for this unit (AD-14), you can connect it to an iPad.

- 1.** Set  to ON.

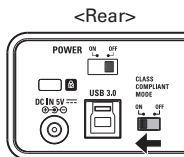

NOTE

- Turn the power OFF before changing the CLASS COMPLIANT MODE switch setting. If the power is already ON, changing the CLASS COMPLIANT MODE switch will have no effect.

- 2.** Plug the AD-14 adapter designed for this unit into an outlet.

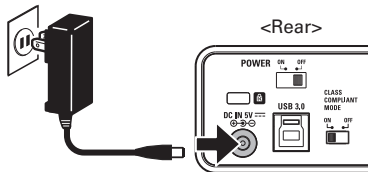

- 3.** Connect the **UAC-2** and the iPad using an Apple iPad Camera Connection Kit or Lightning to USB Camera Adapter.

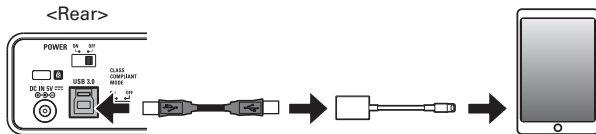

- 4.** Set **POWER** ON OFF to ON.

After the **UAC-2** turns on, it will connect to the iPad.

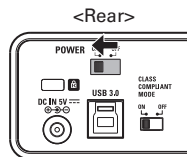

Connecting Instruments

Connect instruments to INPUTS 1/2 using TRS/mono phone cables.

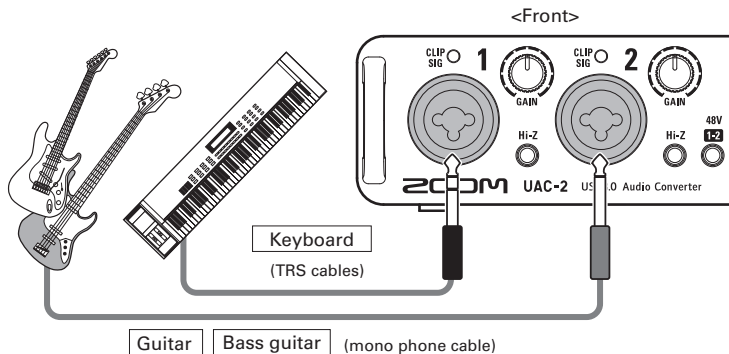

Using the Hi-Z Function

- When connecting a passive guitar or bass guitar to an INPUT, press its **Hi-Z** so that it lights.
- When connecting a keyboard or other instrument to an INPUT, press its **Hi-Z** so that it becomes unlit.

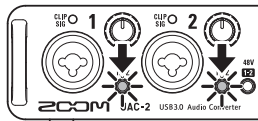

Connecting Mics

Using XLR cables, connect mics to INPUTS 1/2.

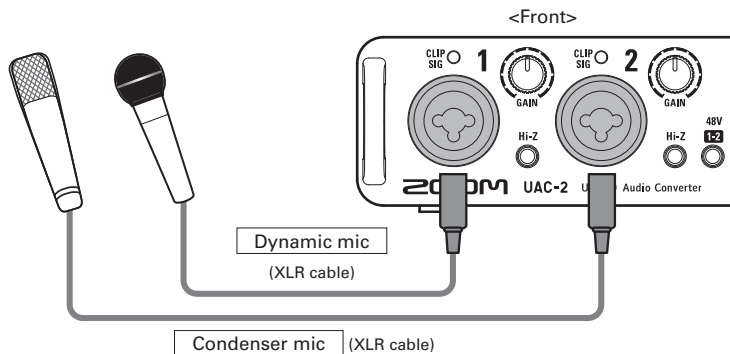

Using Phantom Power

- When connecting a condenser mic, press  so that it lights. Phantom power is supplied when this switch is lit.
- When on, phantom power is supplied to both INPUTS 1/2.

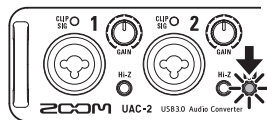

Adjusting Input Gain

You can adjust the gain of each INPUT.

1. Check the status of the input signal.

Lit green: Input signal present.

Lit red: Input signal is clipping.

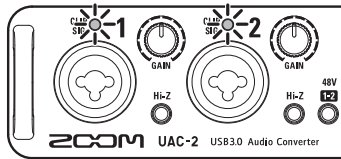

2. Adjust the input gain.

Turn the .

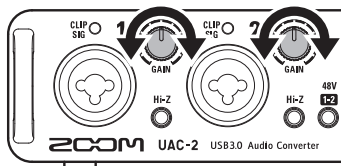

HINT

- Set it so that the level indicator does not light red.

Connecting Headphones and Speakers

Connect headphones to the PHONES jack and speakers to the OUTPUT jacks. Then, adjust the volume.

1. Connect headphones or speakers.

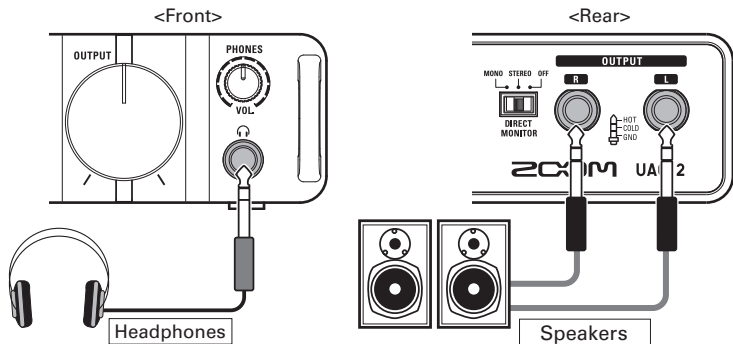

2. Adjust the headphones/speakers volume.

Headphones volume: Turn  .

Speakers volume: Turn  .

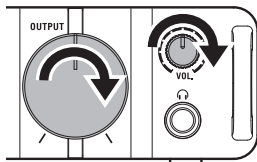

Using Direct Monitoring

Sound inputs into the **UAC-2** can be directly output without passing through the computer. This enables monitoring without latency.

1. Set the  .

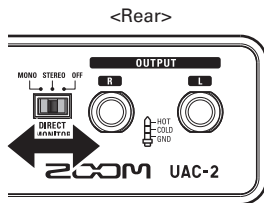

Direct monitoring setting	INPUT 1 jack	INPUT 2 jack
MONO	Output from the PHONES jack and both L/R OUTPUT jacks.	
STEREO	Output from the PHONES jack and the L OUTPUT jack.	Output from the PHONES jack and the R OUTPUT jack.
OFF	This disables direct monitoring.	

Connecting MIDI Devices

Use MIDI cables to connect MIDI devices to the MIDI IN and MIDI OUT jacks.

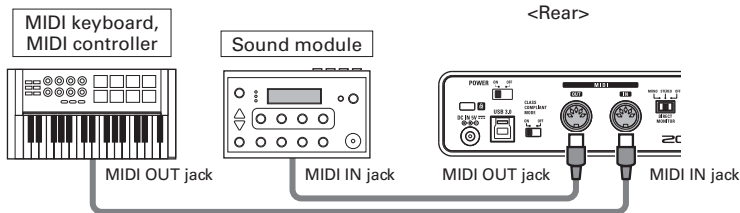

NOTE

- When using a MIDI port with a DAW, for example, follow the instructions below when making settings.

The **UAC-2** or **UAC-2 MixEfx** might not function properly otherwise.

Windows

Use ZOOM UAC-2 MIDI. Do not use MIDI IN/OUT 2 (ZOOM UAC-2 MIDI).

Mac

Use ZOOM UAC-2 MIDI I/O Port. Do not use ZOOM UAC-2 Reserved Port.

Restoring Factory Default Settings

Follow these instructions to initialize settings, restoring them to their factory defaults.

1. Turn the power ON while pressing . (→P.7)

2. Initialize the settings.

Execute: Press .

Cancel: Press .

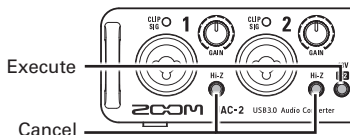

Troubleshooting

Cannot select or use the UAC-2 device

- Confirm that the **UAC-2** is connected to the computer correctly.
- Quit all the software that is using the **UAC-2**, and disconnect and reconnect the USB cable connected to the **UAC-2**.
- Reinstall the driver.
- Connect the **UAC-2** directly to a USB port on the computer. Do not connect it to a USB hub.

Playback sound cannot be heard or is quiet

- Check the speaker connections and volume settings on the speakers.
- Adjust the OUTPUT and PHONES volume controls.
- Confirm that the Sound setting of the computer that you are using is set to "ZOOM UAC-2".

Recorded audio is too loud, too quiet or silent

- Adjust the input gain of the **UAC-2**.
- When using a condenser mic, turn phantom power on.
- Confirm that the Sound setting of the computer that you are using is set to "ZOOM UAC-2".

The sound of the device connected to the input jack is distorted

- Confirm that the level indicators are not lighting red. If they are lighting, lower the input levels.

Sound skips during playback or recording

- If you can adjust the audio buffer size of the software that you are using, increase the buffer size.
- Turn the automatic sleep function and other computer power saving settings OFF.
- Connect the **UAC-2** directly to a USB port on the computer. Do not connect it to a USB hub.

Cannot play or record

- Confirm that the Sound setting of the computer that you are using is set to "ZOOM UAC-2".
- Confirm that **UAC-2** is set for input and output in the software that you are using.
- Confirm that **UAC-2** is connected to the computer correctly.
- Quit all the software that is using the **UAC-2**, and disconnect and reconnect the USB cable connected to the **UAC-2**.

Cannot use with an iPad

- Turn Class Compliant Mode ON. (→P.8)
- Confirm that the AD-14 adapter designed for this unit is connected.

Specifications

Inputs	INPUT 1/2	Connector	XLR/TRS combo jacks (XLR: 2 hot, TRS: TIP hot)
		Input gain	0–60 dB (in 1dB steps)
		Input impedance	5 k Ω 1 M Ω (when Hi-Z ON)
		Maximum input level	+12 dBu (at 0 dBFS)
		Phantom power	+48V
Outputs	OUTPUT L/R	Connector	TRS jack (balanced)
		Maximum output level	+14 dBu (at 0 dBFS)
		Output impedance	100 Ω
	PHONES	Connector	Standard stereo phone jack 20 mW \times 2 (into 32 Ω load)
		Maximum output level	+8 dBu (at 0 dBFS)
		Output impedance	33 Ω
Frequency characteristics		At 44.1 kHz	-1.0 dB: 20 Hz – 20 kHz
		At 96 kHz	-1.0 dB: 20 Hz – 40 kHz
		At 192 kHz	-1.0 dB: 20 Hz – 60 kHz
Input conversion noise		Measured EIN: -125 dBu (IHF-A) (with 60dB, 150 Ω input)	
Dynamic range		AD: 118 dB typical (IHF-A)	DA: 120 dB typical (IHF-A)
Number of audio recording and playback channels		Recording: 2 channels	Playback: 2 channels
Sampling frequencies		192 kHz, 176.4 kHz, 96 kHz, 88.2 kHz, 48 kHz, 44.1 kHz	
Bit depth		24-bit	
Interface		USB3.0 / 2.0	
MIDI IN/OUT		5 pin DIN jack	
Power Source		USB bus power / AD-14 AC adapter (DC 5V/1A) (sold separately)	
Power consumption		5 W maximum	
Dimensions		113.9 mm (D) \times 176.0 mm (W) \times 46.2 mm (H)	
Weight (main unit only)		750 g	

- 0 dBu = 0.775 Vrms

FCC regulation warning (for U.S.A.)

This equipment has been tested and found to comply with the limits for a Class B digital device, pursuant to Part 15 of the FCC Rules. These limits are designed to provide reasonable protection against harmful interference in a residential installation. This equipment generates, uses, and can radiate radio frequency energy and, if not installed and used in accordance with the instructions, may cause harmful interference to radio communications. However, there is no guarantee that interference will not occur in a particular installation. If this equipment does cause harmful interference to radio or television reception, which can be determined by turning the equipment off and on, the user is encouraged to try to correct the interference by one or more of the following measures:

- Reorient or relocate the receiving antenna.
- Increase the separation between the equipment and receiver.
- Connect the equipment to an outlet on a circuit different from that to which the receiver is connected.
- Consult the dealer or an experienced radio/TV technician for help.

For EU Countries



Declaration of Conformity

zoom[®]

ZOOM CORPORATION

4-4-3 Kanda-Surugadai, Chiyoda-ku, Tokyo 101-0062 Japan

<http://www.zoom.co.jp>